



Bariatric examination couch
Range OVALIA-MAX
OVALIA-MAX

CARINA
Medical



CE
ISO 9001
ISO 13485

TECHNICAL DETAILS

- 2 sections examination couch with electric height adjustment
- Control: Multifonctionnal hand remote
- Head rest adjustment in every positions with electric jack
- Flat upholstery with good density 40kg/cm², fire retardant M1 class, thickness 10cm
- Equipped with paper roll holder for exam sheet, on the head side
- Epoxy covering, colour sand
- On 4 removable wheels, diam. 35mm to move the couch when empty

DIMENSIONS

- Width 90cm
- Adjustable height from 50 to 90cm
- Load capacity: 380kg in dynamic

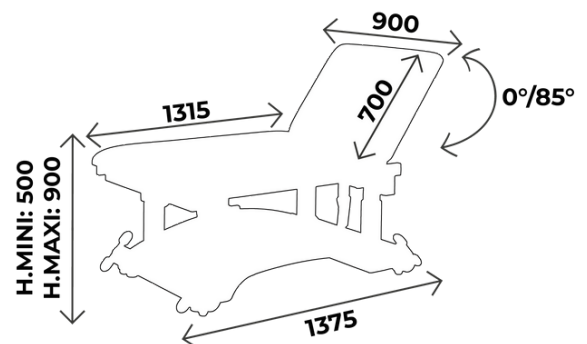

WHAT YOU NEED TO KNOW

- ✓ Delivery time: 15 days upon receipt of order
- ✓ Warranty: 5 years (1 year for the upholstery)

ACCESSORIES

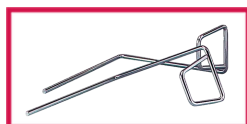

ACC 105
Pair of stainless steel stirrups
diam. 14mm, without clamp



ACC 964
Pair of legrests on knee system
in black polyurethane,
diam. 14mm, without clamp



SLFMIREPOSE
Cover for legrests ACC964
in upholstery, the unit



ACC 514-UNIVERSE
Plastic protection cover
For all couches



ACC 110
Blood test splint in colour
without clamp, the unit



ACC 110POLY
Polyurethane blood test splint
without clamp, the unit



ACC BARRILITOV09
Pair of retractable security ride rails
For couches width 900mm



ACC BATTERIE01
Battery, capacity 20 cycles
(1 cycle = 1x height's up/ down +
1x backrest's up/ down)



ACC TETERGO
Ergonomic head rest



ACC 76-OVALIAMAX
Pair of clamps to fix accessories
(Stirrups, legrests, ..)

UPHOLSTERY'S COLOURS

Fire retardant
upholstery, M1 class

*For the upholstery colours, you can choose between the Classic and Urban range
Be careful ! Urban colours with extra value*

Upholstery: Classic range

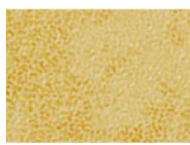

Arno



Garonne



Potomac



Amour

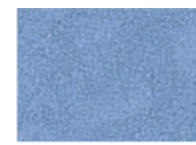

Mississippi

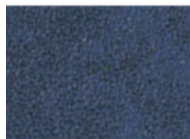

St Laurent

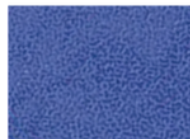

Rhône



Missouri



Seine

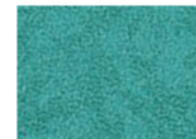

Amazone

Upholstery: Urban range



Abysses

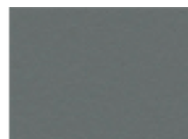

Cendre



Origan



Géranium



Réglice



Prune

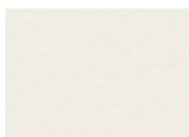

Perle

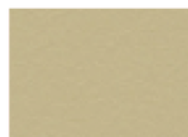

Ficelle

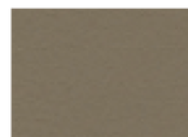

Terre

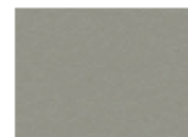

Béton

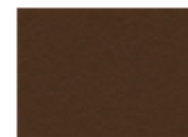

Chataigne

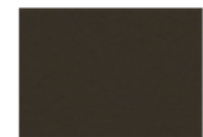

Chocolat

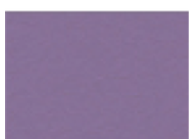

Pensée



Pétrole



Turquoise



Granny



Absinthe



Ananas



Orange



Fuschia



Tomate



**BASE
COLOURS**



RAL 9003



RAL 1013



RAL 1015



RAL 6019



RAL 6033



RAL 6000



RAL 5017



RAL 5002



RAL 5000

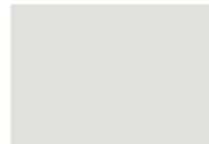

RAL 7035



RAL 7016



RAL 9005



RAL 1018



RAL 3020



RAL 3003

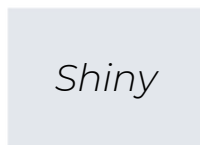

SILVER



MAINTENANCE GUIDE

DAILY MAINTENANCE

Upholstery: Cleaning with soapy water only (no solvents), can be disinfected with products such as Phagosept Spray, Salvaniol pH10 at 0.75% and Anios Surfaces Hautes, without abrasive material

Base: cleaning with soapy water only (no solvents) without abrasive materials

WARRANTY

Mechanical/ electrical part: 5 years

Upholstery: 1 year



CONTACT

CARINA
Médical

Parc d'entreprises Visionis
278 rue de l'industrie
01090 GUÉREINS- FRANCE

COMMERCIAL SERVICE

Tel: +33(0)4 74 66 69 49
Fax: +33(0)4 74 66 69 50
export@carinamedical.com