



Physiotherapy table

ECOMAX range
ECOMAXKINE700

CARINA
Medical



CE
ISO 9001
ISO 13485

TECHNICAL DETAILS

- 2 sections physiotherapy table
- Adjustment of the head rest in every position with a gas jack
- Stretched upholstery with good density 24kg/cm², M2 fire retardant class, thickness 6 cm
- Equipped with paper roll holder: possibility to fix it on foot or head side
- Full welded table: Very resistant
- Epoxy covered base, silver color in standard

DIMENSIONS

- Width: 700mm
- Height: 800mm
- Load capacity: 150kg

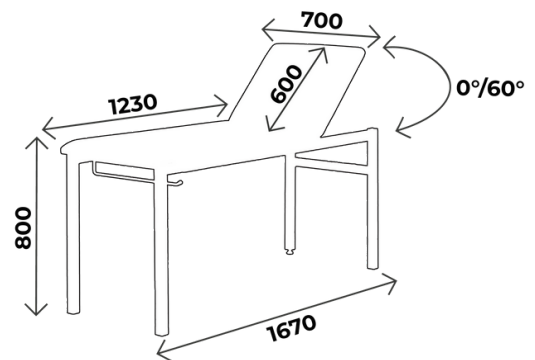

You may also like :

Réf. ECOMAXKINE600 : Same as ECOMAXKINE700 but width 600mm



WHAT YOU NEED TO KNOW

- ✓ Delivery time: 15 days upon receipt of order
- ✓ Warranty: 2 years (1 year for the upholstery)

ACCESSORIES

CUSHIONS



COUSSIN-001

Rectangular cushion with HR foam
dim. 440x200x75mm



COUSSIN-002

Half cylindric cushion HR foam,
dim 450x120mm, radius 120mm



COUSSIN-003

Cylindric cushion with HR foam
dim. 500x160mm

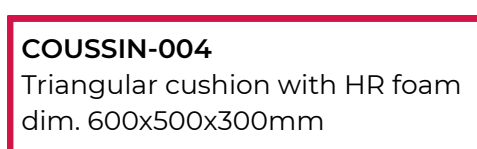

COUSSIN-004

Triangular cushion with HR foam
dim. 600x500x300mm

UPHOLSTERY'S COLOURS

Fire retardant
upholstery, M2 class

For the upholstery colours, you can choose between the Ecomax, Classic and Urban range
Be careful ! Classic and Urban colours **with extra value**

Upholstery: ECOMAX* range



Galapagos



Bahamas



Blanc



Tahiti



Malouines

**Standard colors for ECOMAX, SIMPLEX and PRISCA ranges,
Classic and Urban colors available on demand*



UPHOLSTERY'S COLOURS

Fire retardant
upholstery, M1 class

For the upholstery colours, you can choose between the Classic and Urban range
Be careful ! Classic and Urban colours **with extra value**

Upholstery: Classic range

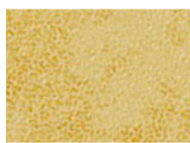

Arno



Garonne



Potomac



Amour

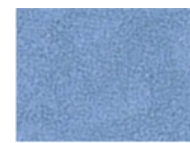

Mississippi

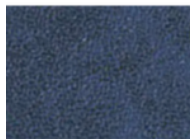

St Laurent



Rhône



Missouri



Seine



Amazone

Upholstery: Urban range



Abysses

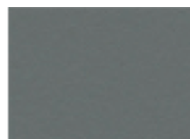

Cendre



Origan



Géranium



Régilisse



Prune

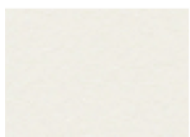

Perle

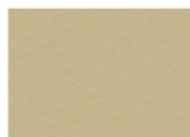

Ficelle

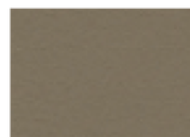

Terre

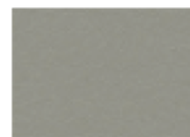

Béton



Chataigne

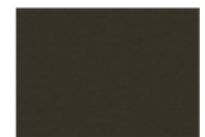

Chocolat

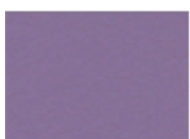

Pensée



Pétrole



Turquoise



Granny



Absinthe



Ananas



Orange



Fuschia



Tomate



MAINTENANCE GUIDE

DAILY MAINTENANCE

Upholstery: Cleaning with soapy water only (no solvents), can be disinfected with products such as Phagosept Spray, Salvaniol pH10 at 0.75% and Anios Surfaces Hautes, without abrasive material

Base: cleaning with soapy water only (no solvents) without abrasive materials

WARRANTY

Mechanical/ electrical part: 2 years

Upholstery: 1 year



CONTACT

CARINA
Médical

Parc d'entreprises Visionis
278 rue de l'industrie
01090 GUÉREINS- FRANCE

COMMERCIAL SERVICE

Tel: +33(0)4 74 66 69 49
Fax: +33(0)4 74 66 69 50
export@carinamedical.com