



Electric physiotherapy table

777 range

777 02-PREMIUM

CARINA
Medical



CE
ISO 9001
ISO 13485

TECHNICAL DETAILS

- 2 sections physiotherapy table, with electric height adjustment
- All around controller
- Adjustment of the head rest in every position with a gas jack
- Stretched upholstery with good density 75kg/cm², HR60+HR40 visco foam, M1 fire retardant class, thickness 7 cm (with include comfort foam of 10mm on the top)
- Height adjustment with an electric jack of 6000N capacity
- Face hole to give a better confort to patients, with plug cushion
- Epoxy covered base, light grey color (RAL7035) in standard
- With 4 retractable wheels diam 75mm

DIMENSIONS

- Width 600mm, backrest length 760mm
- Adjustable height from 50 to 99cm
- Load capacity: 150kg in dynamic

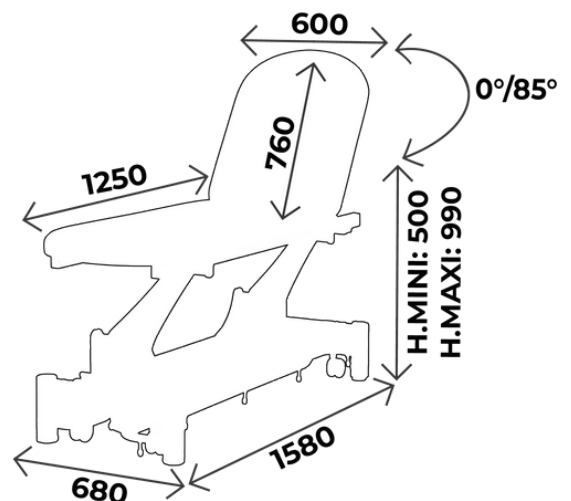

Perfect upholstery's
density for
physiotherapists

You may also like :

Réf. 77702-LIGHT : Same as 77702-PREMIUM but without wheels, pedal control and harder foam HR42



WHAT YOU NEED TO KNOW

- ✓ Delivery time: 15 days upon receipt of order
- ✓ Warranty: 2 years (1 year for the upholstery)

ACCESSORIES



ACC 125-KINE
Paper roll holder
for tables width 600mm



KINEGYNECO
Pair of chromed stirrups and clamps



GYNECOLUXE
Pair of legrests and clamps



SLFEMIREPOSE
Cover for legrests ACC964
in upholstery, the unit

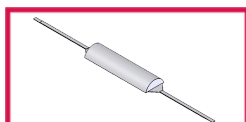

ACC 54001
Half moon headrest width 600mm
fire retardant M1 class

CUSHIONS

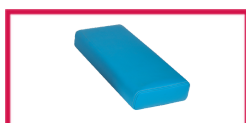

COUSSIN-001
Rectangular cushion with HR foam
dim. 440x200x75mm



COUSSIN-002
Half cylindrical cushion HR foam,
dim 450x120mm, radius 120mm



COUSSIN-003
Cylindric cushion with HR foam
dim. 500x160mm

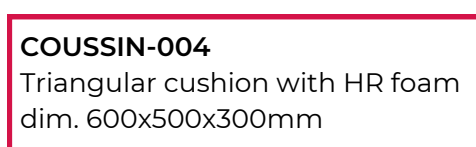

COUSSIN-004
Triangular cushion with HR foam
dim. 600x500x300mm

UPHOLSTERY'S COLOURS

Fire retardant
upholstery, M1 class

For the upholstery colours, you can choose between the Classic and Urban range

Upholstery: Classic range

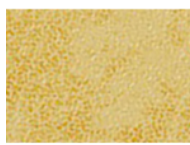

Arno



Garonne



Potomac



Amour



Mississippi

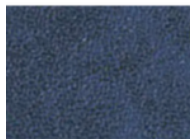

St Laurent

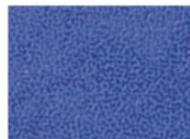

Rhône



Missouri



Seine



Amazone

Upholstery: Urban range



Abysses

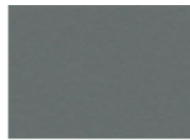

Cendre



Origan

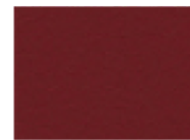

Géranium

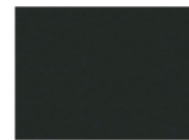

Régilisse

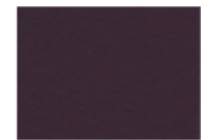

Prune

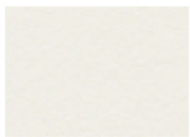

Perle

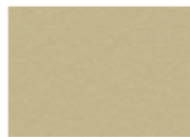

Ficelle

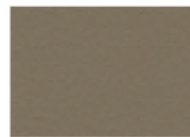

Terre

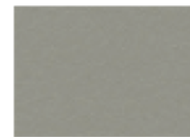

Béton

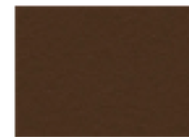

Chataigne

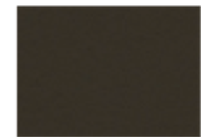

Chocolat

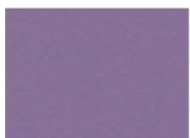

Pensée



Pétrole



Turquoise



Granny



Absinthe



Ananas



Orange



Fuschia



Tomate



BASE COLOURS

*All the 777 range have a base grey in standard
Possibility to change without extra value*



RAL 9003



RAL 1013



RAL 1015

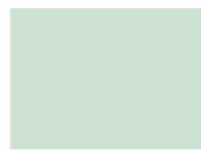

RAL 6019



RAL 6033



RAL 6000



RAL 5017



RAL 5002



RAL 5000

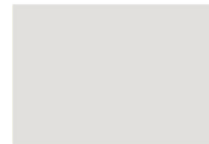

RAL 7035



RAL 7016



RAL 9005



RAL 1018



RAL 3020



RAL 3003

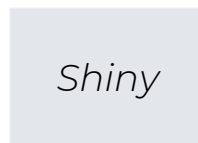

SILVER



MAINTENANCE GUIDE

DAILY MAINTENANCE

Upholstery: Cleaning with soapy water only (no solvents), can be disinfected with products such as Phagosept Spray, Salvaniol pH10 at 0.75% and Anios Surfaces Hautes, without abrasive material

Base: cleaning with soapy water only (no solvents) without abrasive materials

WARRANTY

Mechanical/ electrical part: 2 years

Upholstery: 1 year



CONTACT

CARINA
Médical

Parc d'entreprises Visionis
278 rue de l'industrie
01090 GUÉREINS- FRANCE

COMMERCIAL SERVICE

Tel: +33(0)4 74 66 69 49
Fax: +33(0)4 74 66 69 50
export@carinamedical.com