



*Fixed height sampling chair*

**525 range**

**525 02**

**CARINA**  
*Medical*



**CE**  
ISO 9001  
ISO 13485

## TECHNICAL DETAILS

- 3 sections sampling chair with fixed height 52cm
- Backrest and legrest adjustment with mechanic systems
- The leg rest maybe positioned vertically
- Trendelenburg position
- Upholstery with visible seam with good density 35kg/cm<sup>2</sup>, M1 fire retardant class, thickness 8cm
- Equipped with 2 blood test splints, adjustable in every positions with serrated blocks system
- Epoxy covering, light grey colour (RAL 7035) in standard

## DIMENSIONS

- Width 55cm
- Height 52cm
- Load capacity : 130kg

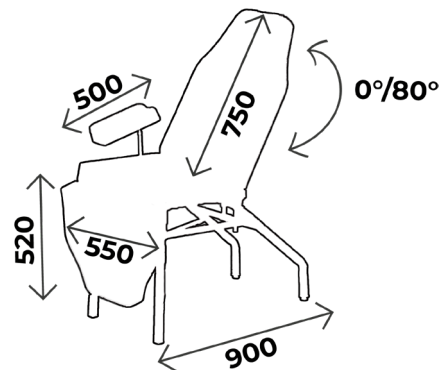

## OTHER ELEMENTS

All our chairs can be put in **lying position**

### You may also like :

Ref. **525 01** : Same as 525 02 but height 75cm



## WHAT YOU NEED TO KNOW

- ✓ Delivery time: 15 days upon receipt of order
- ✓ Warranty : 2 years (1 year for the upholstery)

# ACCESSORIES



**ACC 537**  
Pair of clamps diam. 14mm for blood test splints and stirrups for all ranges except LUVIA



**ACC 535**  
Pair of double clamps diam. 14 and diam. 16mm to fix both armrest and infusion stand

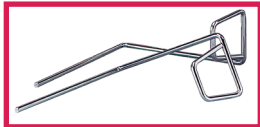

**ACC 105**  
Pair of stainless steel stirrups diam. 14mm without clamp



**ACC 964**  
Pair of legrests on knee system in black polyurethane, diam. 14 mm, without clamp



**SLFEMIREPOSE**  
Cover for legrests ACC964 in upholstery, the unit



**ACC 514-GOUT**  
Plastic protection for blood test splint, the unit



**ACC 514-ASSISE**  
Plastic protection for seatrest



**ACC514/525-JAMB**  
Plastic protection for legrest



**ACC 517-512**  
Plastic protection for backrest

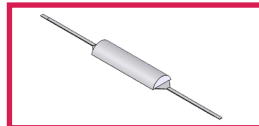

**ACC 54005**  
Half moon head rest width 55cm fire retardant M1 class



**ACC 910-PLAT02**  
Stainless steel tray 340x340 with clamp



**ACC 910-PLAT04**  
Plastic tray 350x270 with clamp



**ACC 113U**  
Pair of handles without clamp with U shape



**ACC 113U**  
Pair of handles without clamp with U shape



**ACC 32012**  
Stainless steel infusion stand diam. 16mm, 2 plastic hooks, without clamp



**ACC 32014**  
Stainless steel infusion stand diam. 16mm, 2 stainless steel hooks without clamp



**ACC TETERGO**  
Ergonomic headrest

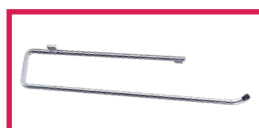

**ACC 125**  
Paper roll holder for all models

# UPHOLSTERY'S COLOURS

Fire retardant  
upholstery, M1 class

For the upholstery colours, you can choose between the Classic and Urban range  
Be careful ! Urban colours **with extra value**

## *Upholstery : Classic range*



Arno



Garonne



Potomac

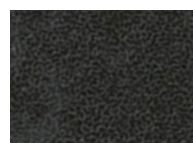

Amour



Mississippi

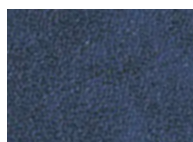

St Laurent



Rhône

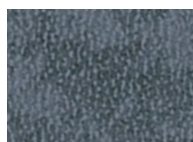

Missouri



Seine

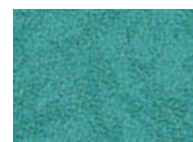

Amazone

## *Upholstery : Urban range*



Abysses

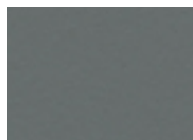

Cendre



Origan



Géranium



Réglisse



Prune

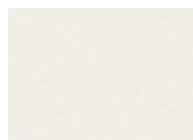

Perle

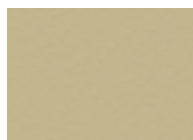

Ficelle

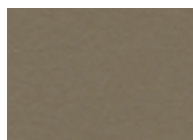

Terre

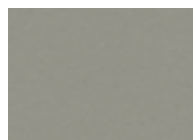

Béton

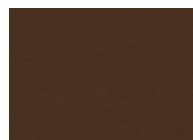

Chataigne

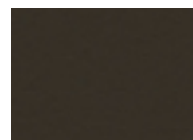

Chocolat

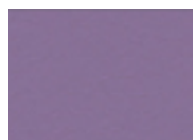

Pensée



Pétrole



Turquoise



Granny



Absinthe



Ananas



Orange



Fuschia





Tomate



## BASE COLOURS

The entire 525 range is offered in light grey (RAL 7035) as standard  
Possibility to change the color without extra charge

### *Base colour*

				
<b>RAL 9003</b>	<b>RAL 1013</b>	<b>RAL 1015</b>	<b>RAL 6019</b>	<b>RAL 6033</b>
				
<b>RAL 6000</b>	<b>RAL 5017</b>	<b>RAL 5002</b>	<b>RAL 5000</b>	<b>RAL 7035</b>
				
<b>RAL 7016</b>	<b>RAL 9005</b>	<b>RAL 1018</b>	<b>RAL 3020</b>	<b>RAL 3003</b>
				
		<b>SILVER</b>		



# MAINTENANCE GUIDE

## **DAILY MAINTENANCE**

Upholstery : Cleaning with soapy water only (no solvents), can be disinfected with products such as Phagosept Spray, Salvanios pH10 at 0.75% and Anios Surfaces Hautes, without abrasive material

Base : cleaning with soapy water only (no solvents) without abrasive materials

## **WARRANTY**

Mechanical/ electrical part : 2 years

Upholstery : 1 year



**CONTACT**

**CARINA**  
*Médical*

Parc d'entreprises Visionis  
278 rue de l'industrie  
01090 GUÉREINS- FRANCE

**COMMERCIAL DEPARTMENT**

Tél : +33(0)4 74 66 69 49  
Fax : +33(0)4 74 66 69 50  
[export@carinamedical.com](mailto:export@carinamedical.com)