



Fixed height sampling chair

525 range

525 01

CARINA
Medical



CE
ISO 9001
ISO 13485

TECHNICAL DETAILS

- 3 sections sampling chair with fixed height 75cm
- Backrest and legrest adjustment with mechanic systems
- The leg rest maybe positioned vertically
- Trendelenburg position
- Upholstery with visible seam with good density 35kg/cm², M1 fire retardant class, thickness 8cm
- Equipped with 2 blood test splints, adjustable in every positions with serrated blocks system
- Epoxy covering, light grey colour (RAL 7035) in standard

DIMENSIONS

- Width 55cm
- Height 75cm
- Load capacity : 130kg

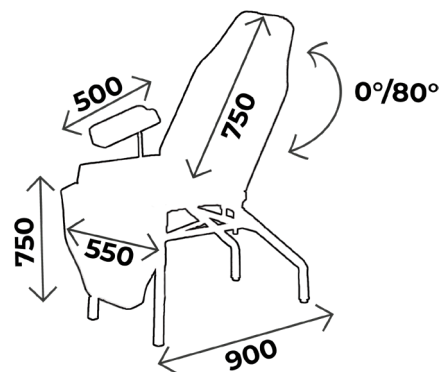

OTHER ELEMENTS

All our chairs can be put in **lying position**

You may also like :

Ref. **525 02** : Same as 525 01 but height 52cm



WHAT YOU NEED TO KNOW

- ✓ Delivery time: 15 days upon receipt of order
- ✓ Warranty : 2 years (1 year for the upholstery)

ACCESSORIES



ACC 537
Pair of clamps diam. 14mm for blood test splints and stirrups for all ranges except LUVIA



ACC 535
Pair of double clamps diam. 14 and diam. 16mm to fix both armrest and infusion stand

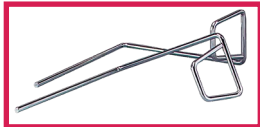

ACC 105
Pair of stainless steel stirrups diam. 14mm without clamp



ACC 964
Pair of legrests on knee system in black polyurethane, diam. 14 mm, without clamp



SLFEMIREPOSE
Cover for legrests ACC964 in upholstery, the unit



ACC 514-GOUT
Plastic protection for blood test splint, the unit



ACC 514-ASSISE
Plastic protection for seatrest



ACC514/525-JAMB
Plastic protection for legrest



ACC 517-512
Plastic protection for backrest

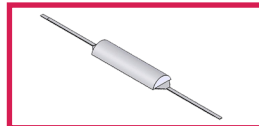

ACC 54005
Half moon head rest width 55cm fire retardant M1 class



ACC 910-PLAT02
Stainless steel tray 340x340 with clamp



ACC 910-PLAT04
Plastic tray 350x270 with clamp



ACC 113U
Pair of handles without clamp with U shape



ACC 113U
Pair of handles without clamp with U shape



ACC 32012
Stainless steel infusion stand diam. 16mm, 2 plastic hooks, without clamp



ACC 32014
Stainless steel infusion stand diam. 16mm, 2 stainless steel hooks without clamp



ACC TETERGO
Ergonomic headrest

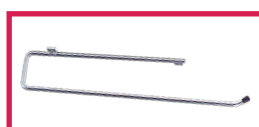

ACC 125
Paper roll holder for all models

UPHOLSTERY'S COLOURS

Fire retardant
upholstery, M1 class

For the upholstery colours, you can choose between the Classic and Urban range
Be careful ! Urban colours **with extra value**

Upholstery : Classic range



Upholstery : Urban range







BASE COLOURS

The entire 525 range is offered in light grey (RAL 7035) as standard
Possibility to change the color without extra charge

Base colour

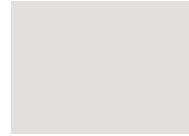
				
RAL 9003	RAL 1013	RAL 1015	RAL 6019	RAL 6033
				
RAL 6000	RAL 5017	RAL 5002	RAL 5000	RAL 7035
				
RAL 7016	RAL 9005	RAL 1018	RAL 3020	RAL 3003
				
		<i>Shiny</i>		
		SILVER		



MAINTENANCE GUIDE

DAILY MAINTENANCE

Upholstery : Cleaning with soapy water only (no solvents), can be disinfected with products such as Phagosept Spray, Salvanios pH10 at 0.75% and Anios Surfaces Hautes, without abrasive material

Base : cleaning with soapy water only (no solvents) without abrasive materials

WARRANTY

Mechanical/ electrical part : 2 years

Upholstery : 1 year



CONTACT

CARINA
Médical

Parc d'entreprises Visionis
278 rue de l'industrie
01090 GUÉREINS- FRANCE

COMMERCIAL DEPARTMENT

Tél : +33(0)4 74 66 69 49
Fax : +33(0)4 74 66 69 50
export@carinamedical.com