

Foldable suitcase table

117 range

117 01

CARINA
Medical



CE
ISO 9001
ISO 13485

TECHNICAL DETAILS

- Foldable suitcase table
- Black stretched upholstery, thickness 4 cm
- With transport handle and security systems to lock the foots
- Epoxy covered base, silver colour

DIMENSIONS

- Width 560mm
- Height: 800mm
- Load capacity: 110kg
- Table weight : 20kg

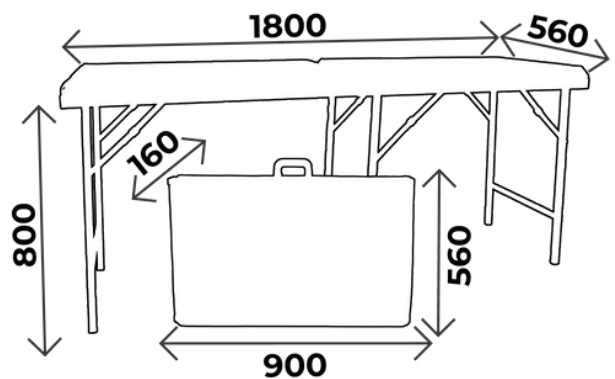

You may also like :

Réf. 117 02 : Same as 117 01 but white upholstery



WHAT YOU NEED TO KNOW

- ✓ Delivery time: 15 days upon receipt of order
- ✓ Warranty: 2 years (1 year for the upholstery)

ACCESSORIES



ACC 11703

Plastic cover for suitcase table

CUSHIONS

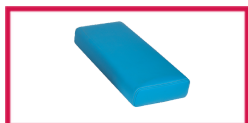

COUSSIN-001

Rectangular cushion with HR foam
dim. 440x200x75mm



COUSSIN-002

Half cylindric cushion HR foam,
dim 450x120mm, radius 120mm



COUSSIN-003

Cylindric cushion with HR foam
dim. 500x160mm

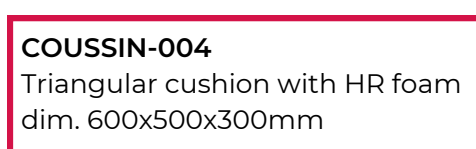

COUSSIN-004

Triangular cushion with HR foam
dim. 600x500x300mm

UPHOLSTERY'S COLOURS

Fire retardant
upholstery, M1 class

*For the upholstery colours, you can choose between the Classic and Urban range
Be careful ! Urban colours with extra value*

Upholstery: Classic range

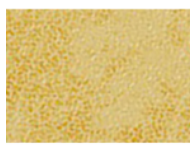

Arno



Garonne



Potomac



Amour



Mississippi

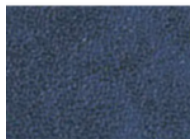

St Laurent

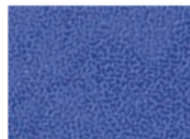

Rhône



Missouri



Seine

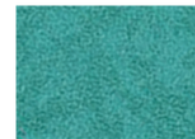

Amazone

Upholstery: Urban range



Abysses

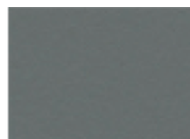

Cendre



Origan



Géranium



Réglice



Prune

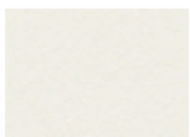

Perle

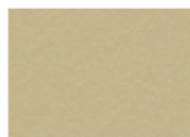

Ficelle

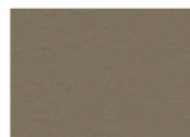

Terre

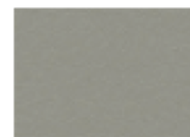

Béton

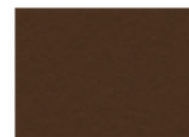

Chataigne

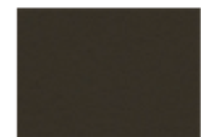

Chocolat



Pensée



Pétrole



Turquoise



Granny



Absinthe



Ananas



Orange



Fuschia



Tomate



BASE COLOURS

*All the 150 range have a silver colored base in standard
Possibility to change without extra value*



RAL 9003



RAL 1013



RAL 1015

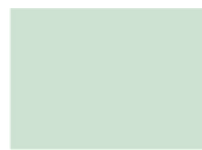

RAL 6019



RAL 6033



RAL 6000



RAL 5017



RAL 5002



RAL 5000

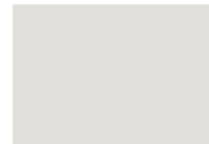

RAL 7035



RAL 7016



RAL 9005



RAL 1018



RAL 3020



RAL 3003

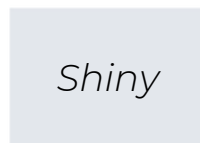

SILVER



MAINTENANCE GUIDE

DAILY MAINTENANCE

Upholstery: Cleaning with soapy water only (no solvents), can be disinfected with products such as Phagosept Spray, Salvaniol pH10 at 0.75% and Anios Surfaces Hautes, without abrasive material

Base: cleaning with soapy water only (no solvents) without abrasive materials

WARRANTY

Mechanical/ electrical part: 2 years

Upholstery: 1 year



CONTACT

CARINA
Médical

Parc d'entreprises Visionis
278 rue de l'industrie
01090 GUÉREINS- FRANCE

COMMERCIAL SERVICE

Tel : +33(0)4 74 66 69 49
Fax : +33(0)4 74 66 69 50
export@carinamedical.com