



Picture of the model with CONFORT type of upholstery

Electric gynaecological chair

GINA range **GINA-HVE**

CARINA
Medical



CE
ISO 9001
ISO 13485



TECHNICAL DETAILS

- 2 sections gynaecological chair with electrical height adjustment
- Control : Hand remote or pedal
- Backrest adjustment with gas jack
- Different type of upholsteries available: SERENITY, CONFORT or PREMIUM — all of those are fire retardant M1 class
- Equipped with a pair of stirrups and a stainless steel drawer
- With paper roll holder on the head side
- Painted steel base, light grey colour RAL 7035 in standard

DIMENSIONS

- Width 55 cm in standard or 65 cm in option
- Height adjustment from 48 cm to 88 cm
- Dynamic load capacity :
150 Kg if ordered with gas jack backrest
200 Kg if ordered with electric backrest and legrest

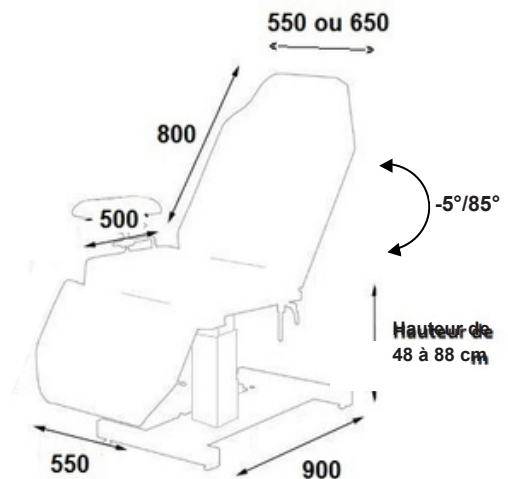

You may also like:

Ref. **GINA-HF** : Fixed height

Ref. **GINA-HVH** : Hydraulic height adjustment



WHAT YOU NEED TO KNOW

✓ Delivery time: 15 days from date of order

✓ Warranty : 5 years

1 year for the upholstery)

ACCESSORIES



SERENITY
Flat upholstery



PREMIUM
Visco elastic foam upholstery



HAND REMOTE



PEDAL



PEDAL WITH MEMORIZATION



RL 125
4 directionnal wheels diam 125 mm , with one brake on each wheel, To move the couch with a patient on



ACC 9505
4 wheels diam 50 mm with individuals breaks To move the couch with nobody on



ACC 964
Pair of leg rests, on ball-joint adjustment system, in black polyurethane, diam 14mm, without clamp



RL50
4 wheels diam 50 mm with individuals breaks To move the couch with nobody on



ACC TETERGO
Ergonomic and removable headrest



ACCCOUSSIN-01
Pillow cushion dim 500 x 400, fire retardant, M1 class

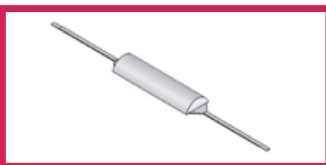

ACC 540 05
Half moon headrest, width 550 mm, fire retardant M1 class



ACC 537
Pair of clamps diam 14mm for arm rests and stirrups, for chairs width 55 cm



DECOUPEURO
Urology cut out of the seatrest



SLFEMIREPOSE
Cover for leg rest ref ACC964, Upholstery colour to be choosed, the unit

ACCESSORIES



ACC444-JMECA
Legrest adjustable through mechanical system



ACC444-JGAZ
Legrest adjustable through gas jack



ACC444-JELEC-2
Electrically adjustable legrest

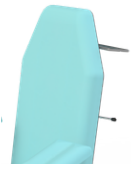

ACC444-DELEC-2
Electrically adjustable backrest



ACC 444-TCDE
Hand remote + Y cable to connect both hand remote and pedal - To be order with electric backrest and legrest options



ACC 444-PEDALE
Pedal + Y cable to connect both pedal and hand remote - To be order with electric backrest and legrest options



ACCACCOU01
Pair of removable arm rests in polyuréthane



ACC 110
Arm rest for blood test, with upholstery, the unit, without clamp



ACC TECH114
Pair of arm rests with one hand adjustment, without clamps



ACCACCOU02
Pair of arm rests with fixation clamps



ACC 110-POLY
Arm rest for blood test in black polyurethane, the unit, without clamp



ACC 110-ROTULE
Arm rest for blood test, with upholstery, on ball joint adjustment system, the unit, without clamp

UPHOLSTERY COLOURS

Fire retardant,
M1 class

Upholstery : Classic range



Upholstery : Urban range



Upholstery : GINKGO range





BASE COLOURS

All the range is suggested with a light grey colour RAL 7035.
Possibility to change this colour without extra costs

Epoxy Painting colours

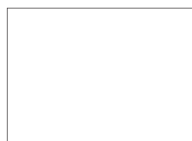

RAL 9003

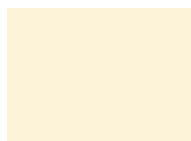

RAL 1013

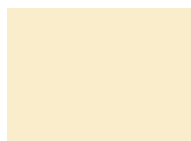

RAL 1015

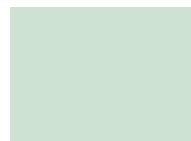

RAL 6019



RAL 6033



RAL 6000



RAL 5017



RAL 5002



RAL 5000

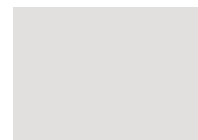

RAL 7035



RAL 7016



RAL 9005



RAL 1018



RAL 3020



RAL 3003

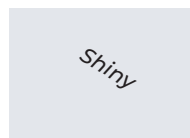

SILVER

MAINTENANCE GUIDE

DAILY MAINTENANCE

Upholstery : Cleaning with soapy water only (no solvents), can be disinfected with products such as Phagosept Spray, Salvanios pH10 at 0.75% and Anios Surfaces Hautes, without abrasive material

Base : cleaning with soapy water only (no solvents) without abrasive materials

WARRANTY

- Structure: 5 years
- Upholstery : 1 year



CONTACT

CARINA
Médical

Parc d'entreprises Visionis
278 rue de l'industrie 01090
GUÉREINS- FRANCE

COMMERCIAL SERVICE

Tél: +33(0)4 74 66 69 49

Fax: +33(0)4 74 66 69 50
export@carinamedical.com