



Divan d'examen hauteur fixe
Gamme ECOMAX
ECOMAXDBLEMIX

CARINA
Medical



CE
ISO 9001
ISO 13485

DESCRIPTION TECHNIQUE

- Divan d'examen double mixte à hauteur fixe, 3 parties gynéco
- Réglage de la tête par 2 crémaillères indexables
- Sellerie tendue plate de bonne densité 24kg/cm², non-feu classée M2, épaisseur 6cm
- Equipé d'un porte-rouleau pour drap d'examen : possibilité de le fixer côté pied ou côté tête
- Avec une paire d'étaux, une paire d'étriers et un bac inox
- Piètement acier peint époxy, coloris argent

DIMENSIONS

- Largeur 60cm
- Hauteur 80cm
- Capacité de charge : 150kg

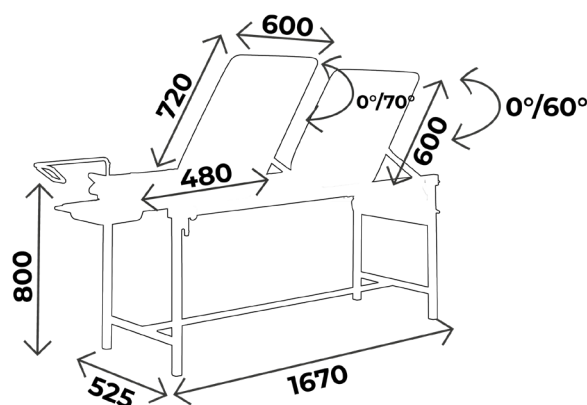

À SAVOIR

- ✓ Livré démonté (plus value montage)
- ✓ Garantie : 5 ans (1 an pour la sellerie)

ACCESSOIRES



ACC 538
Jeu d'étaux diam. 14mm
pour ECOMAX largeur 60cm



ACC 32012
Tige porte-sérum diam. 16mm
2 crochets plastiques, sans étau



ACC 964
Jeu de repose jambes noir,
sur rotule mousse polyuréthane,
diam. 14mm, sans étau



SLFEMIREPOSE
Housse prélude pour repose
jambes (ACC964), l'unité



ACC 110
Gouttière prise de sang
Avec ferrure, sans étau, l'unité



ACC 110POLY
Gouttière prise de sang
polyuréthane avec ferrure
Sans étau, l'unité



ACC 514-UNIVERSE
Protection plastique transparent
universelle

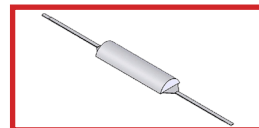

ACC 54001
Tête 1/2 lune largeur 60cm
revêtement non feu M1



ACC 832
Trou visage avec bouchon



ACC BARRILITECOM
Paire de barrières de lit
escamotables largeur 60cm

ACC 538-110
Jeu d'étaux pour gouttières

COLORIS SELLERIE

Sellerie non-feu
classée M2

Pour les coloris de sellerie, vous avez le choix entre la gamme ECOMAX, Classique et Urban
Attention ! coloris Classique et Urban **avec plus value**

*Revêtement : Sellerie Gamme ECOMAX**



Galapagos



Bahamas

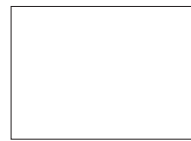

Blanc



Tahiti



Malouines

*Coloris standards pour gamme ECOMAX et SIMPLEX,
coloris Classique et Urban disponibles **sur demande**

COLORIS SELLERIE

Sellerie non-feu
classée M1

Attention ! coloris Classique et Urban **avec plus value**

Revêtement : Sellerie Gamme Classique



Arno



Garonne



Potomac

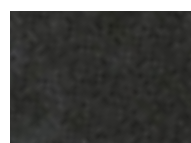

Amour

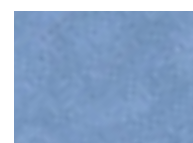

Mississippi



St Laurent



Rhône



Missouri

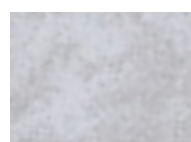

Seine



Amazone

Revêtement : Sellerie Gamme Urban



Abysse



Cendre



Origan



Géranium

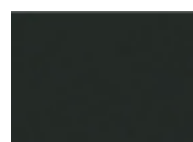

Réglisse



Prune

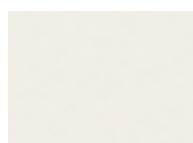

Perle



Ficelle



Terre

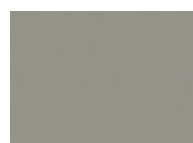

Béton

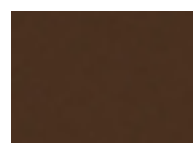

Chataigne



Chocolat



Pensée



Pétrole



Turquoise



Granny



Absinthe



Ananas



Orange



Fuschia



Tomate



GUIDE D'ENTRETIEN

ENTRETIEN QUOTIDIEN

- Sellerie : nettoyage à l'eau savonneuse uniquement (solvants proscrits), peut être désinfecté avec des produits tels que Phagosept Spray, Salvanios pH10 à 0,75% et Anios Surfaces Hautes, sans matière abrasive
- Piètement : nettoyage à l'eau savonneuse uniquement (solvants proscrits) sans matière abrasive

GARANTIE

- Châssis : 5 ans
- Sellerie : 1 an



CONTACT

CARINA *Medical*

Parc d'entreprises Visionis
278 rue de l'industrie
01090 GUÉREINS- FRANCE

SERVICE COMMERCIAL

Tél : +33(0)4 74 66 69 49

Fax : +33(0)4 74 66 69 50

commercial@carinamedical.com