



*Divan d'examen hauteur fixe*

***Gamme ECOMAX***

**ECOMAX**

**CARINA**  
*Medical*



**CE**  
ISO 9001  
ISO 13485

## DESCRIPTION TECHNIQUE

- Divan d'examen à hauteur fixe, 2 parties
- Réglage de la tête par 2 crémaillères indexables
- Sellerie tendue plate de bonne densité 24kg/cm<sup>2</sup>, non-feu classée M2, épaisseur 6cm
- Equipé d'un porte-rouleau pour drap d'examen : possibilité de le fixer côté pied ou côté tête
- Piètement acier peint époxy, coloris argent

## DIMENSIONS

- Largeur 60cm
- Hauteur 80cm
- Capacité de charge : 150kg

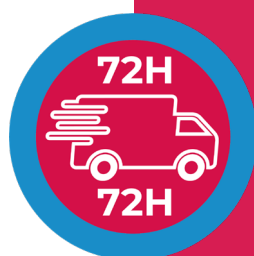
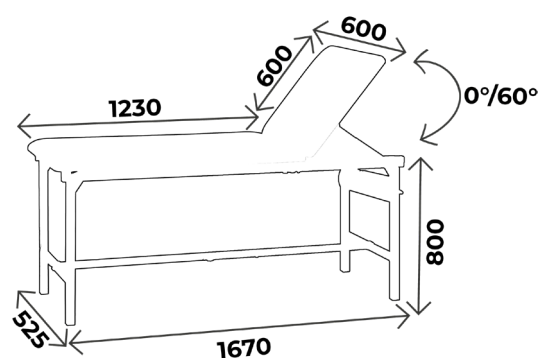

### Vous aimerez aussi :

Réf. **ECOMAX700** : Idem ECOMAX mais largeur 70cm



## À SAVOIR

- ✓ Livré démonté (plus value montage)
- ✓ Garantie : 5 ans (1 an pour la sellerie)

## ACCESSOIRES



**ACC 538**  
Jeu d'étaux diam. 14mm  
pour ECOMAX largeur 60cm

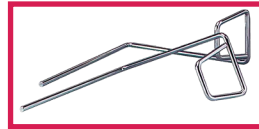

**ACC 105**  
Jeu d'étriers inox standard  
diam. 14mm, sans étai



**ACC 964**  
Jeu de repose jambes noir,  
sur rotule mousse polyuréthane,  
diam. 14mm, sans étai



**SLFEMIREPOSE**  
Housse prélude pour repose  
jambes (ACC964), l'unité



**ACC 538D16**  
Jeu d'étaux diam. 16mm  
pour tige porte-sérum



**ACC 32012**  
Tige porte-sérum diam. 16mm  
2 crochets plastiques, sans étai



**ACC URGENCE03-60**  
Paire de barrières de lit  
escamotables largeur 60cm



**ACC 990**  
Jeu de 4 roulettes à frein  
diam. 125mm



**ACC 832**  
Trou visage avec bouchon



**ACC 514-UNIVERSE**  
Protection plastique transparent  
universelle



**ACC TETERGO**  
Tête ergonomique amovible

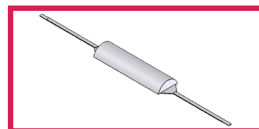

**ACC 54001**  
Tête 1/2 lune largeur 60cm  
revêtement non feu M1



**ACC 110**  
Gouttière prise de sang  
Avec ferrure, sans étai, l'unité



**ACC 110POLY**  
Gouttière prise de sang  
polyuréthane avec ferrure  
Sans étai, l'unité

## COLORIS SELLERIE

Sellerie non-feu  
classée M2

Pour les coloris de sellerie, vous avez le choix entre la gamme ECOMAX, Classique et Urban  
Attention ! coloris Classique et Urban **avec plus value**

### Revêtement : Sellerie Gamme ECOMAX\*



Galapagos



Bahamas

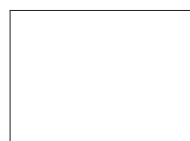

Blanc



Tahiti



Malouines

\*Coloris standards pour gamme ECOMAX et SIMPLEX,  
coloris Classique et Urban disponibles **sur demande**

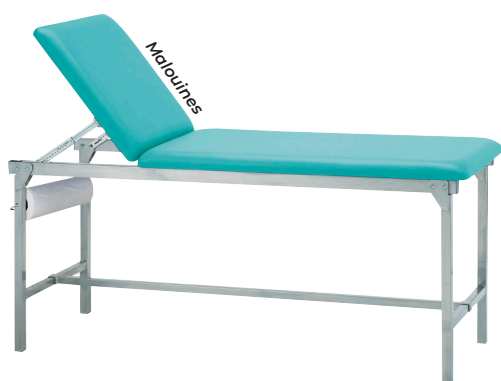

# COLORIS SELLERIE

Sellerie non-feu  
classée M1

Pour les coloris de sellerie, vous avez le choix entre la gamme Classique et Urban  
Attention ! coloris Classique et Urban **avec plus value**

## *Revêtement : Sellerie Gamme Classique*

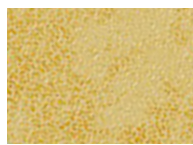

Arno



Garonne



Potomac



Amour

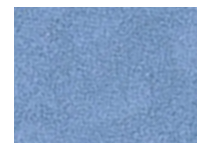

Mississippi

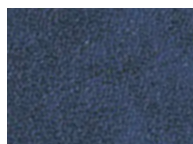

St Laurent



Rhône

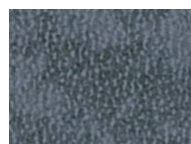

Missouri



Seine

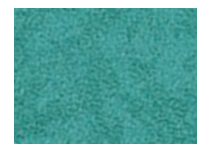

Amazone

## *Revêtement : Sellerie Gamme Urban*



Abysse

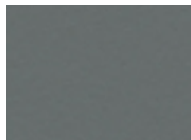

Cendre



Origan



Géranium

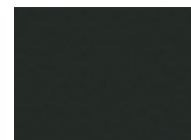

Réglisse



Prune

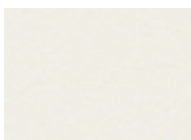

Perle

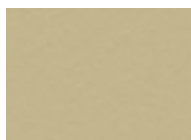

Ficelle

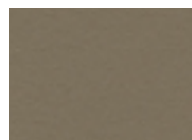

Terre

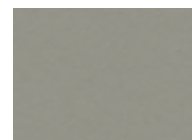

Béton

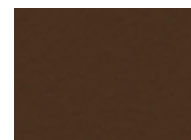

Chataigne

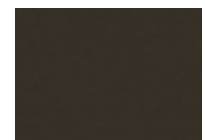

Chocolat

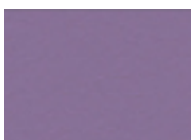

Pensée



Pétrole



Turquoise



Granny



Absinthe



Ananas



Orange



Fuschia



Tomate



## GUIDE D'ENTRETIEN

### ENTRETIEN QUOTIDIEN

- Sellerie : nettoyage à l'eau savonneuse uniquement (solvants proscrits), peut être désinfecté avec des produits tels que Phagosept Spray, Salvanios pH10 à 0,75% et Anios Surfaces Hautes, sans matière abrasive
- Piètement : nettoyage à l'eau savonneuse uniquement (solvants proscrits) sans matière abrasive

### GARANTIE

- Châssis : 5 ans
- Sellerie : 1 an



**CONTACT**

**CARINA**  
*Médical*

Parc d'entreprises Visionis  
278 rue de l'industrie  
01090 GUÉREINS- FRANCE

**SERVICE COMMERCIAL**

Tél : +33(0)4 74 66 69 49  
Fax : +33(0)4 74 66 69 50  
[commercial@carinamedical.com](mailto:commercial@carinamedical.com)