



Fauteuil de gynécologie électrique

**Gamme 725**

**725 01**

**CARINA**  
Medical



**CE**  
ISO 9001  
ISO 13485

## DESCRIPTION TECHNIQUE

- Fauteuil de gynécologie à hauteur variable électrique, 3 parties
- Commande : Pédale
- Dossier et jambièrre réglables par vérins à gaz
- Position de Trendelenburg
- Sellerie tendue plate de bonne densité 35kg/cm<sup>2</sup>, non-feu classée M1, épaisseur 8cm
- Equipé d'un bac inox, d'une paire d'étaux et d'étriers
- Avec porte rouleau pour drap d'examen côté tête
- Piètement acier peint époxy, coloris gris clair (RAL 7035) en standard

## DIMENSIONS

- Largeur 60cm
- Hauteur variable de 62 à 88cm
- Capacité de charge : 130kg

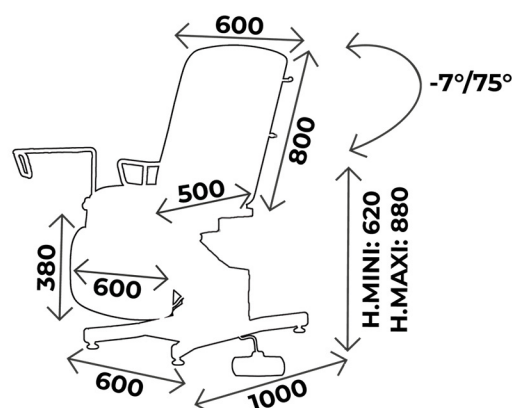

### À SAVOIR

- ✓ Délai : 15 jours à réception commande
- ✓ Garantie : 5 ans (1 an pour la sellerie)

## ACCESSOIRES



**ACC 964**  
Jeu de repose jambes sur rotule en mousse polyuréthane, diam. 14mm, sans étai

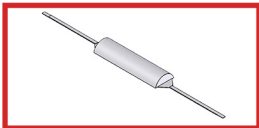

**ACC 54001**  
Têteière 1/2 lune largeur 60cm revêtement non feu M1



**SLFEMIREPOSE**  
Housse prélude pour repose jambes (ACC964), l'unité



**ACC TETERGO**  
Têteière ergonomique amovible

**ACC 514-725-ASS**  
Protection plastique pour assise pour fauteuil 725

**ACC 514-725-JAMB**  
Protection plastique pour jambière pour fauteuil 725



**ACC 725FEMINALED**  
Lampe lumière froide et étai Avec interrupteur sur la tête

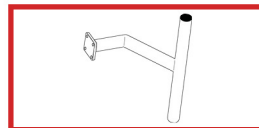

**ACC 63**  
Support colposcope pour 625



**ACC 990**  
Jeu de 4 roulettes à frein diam. 125mm



**ACC RAIL IN-L400**  
Paire rails inox 25x10 longueur 40cm



**ACC 537**  
Jeu d'étaux diam. 14mm pour gouttières



**ACC 110**  
Gouttière prise de sang avec ferrure, sans étai, l'unité



**ACC BARRILIT725**  
Paire de barrières de lit escamotables



**ACC 113U-725**  
Poignées de maintien + étaux de fixation

# COLORIS SELLERIE

Sellerie non-feu  
classée M1

Pour les coloris de sellerie, vous avez le choix entre la gamme Classique et Urban  
Attention ! coloris Urban **avec plus value**

## *Revêtement : Sellerie Gamme Classique*

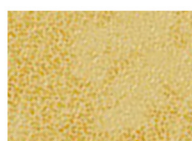

Arno



Garonne



Potomac



Amour

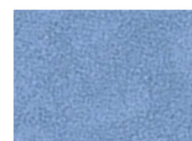

Mississippi



St Laurent

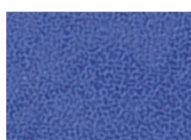

Rhône



Missouri



Seine



Amazone

## *Revêtement : Sellerie Gamme Urban*



Abysse



Cendre



Origan

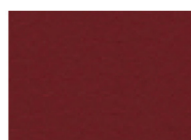

Géranium



Réglisse

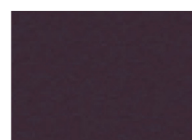

Prune

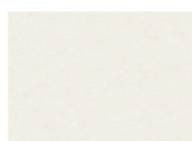

Perle

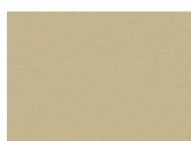

Fi-



Terre

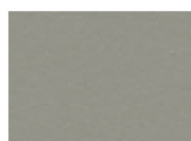

Béton

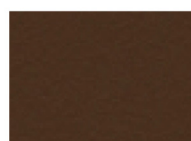

Chataigne



Chocolat

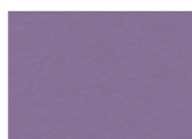

Pensée



Pétrole



Turquoise



Granny



Absinthe



Ananas



Orange



Fuschia



Tomate

# COLORIS PIÈTEMENT

Le fauteuil 725 01 est proposé en coloris (RAL 7035) en standard  
Possibilité de changer le coloris de piètement **sans plus value**

## *Piètement Peinture EPOXY*



**RAL 9003**

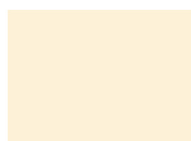

**RAL 1013**

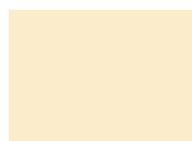

**RAL 1015**



**RAL 6019**



**RAL 6033**



**RAL 6000**



**RAL 5017**



**RAL 5002**



**RAL 5000**



**RAL 7035**



**RAL 7016**



**RAL 9005**



**RAL 1018**



**RAL 3020**



**RAL 3003**

*Attention brillant*

**ARGENT**



# GUIDE D'ENTRETIEN

## ENTRETIEN QUOTIDIEN

- Sellerie : nettoyage à l'eau savonneuse uniquement (solvants proscrits), peut être désinfecté avec des produits tels que Phagosept Spray, Salvanios pH10 à 0,75% et Anios Surfaces Hautes, sans matière abrasive
- Piètement : nettoyage à l'eau savonneuse uniquement (solvants proscrits) sans matière abrasive

## GARANTIE

- Châssis : 5 ans
- Sellerie : 1 an



**CONTACT**

**CARINA**  
*Medical*

Parc d'entreprises Visionis  
278 rue de l'industrie  
01090 GUÉREINS- FRANCE

**SERVICE COMMERCIAL**

Tél: +33(0)4 74 66 69 49  
Fax: +33(0)4 74 66 69 50  
[commercial@carinamedical.com](mailto:commercial@carinamedical.com)