



*Electric multi-treatment chair*  
**MULTIKA V2 range**  
**MULT-V2-700-01**

**CARINA**  
*Medical*



**CE**  
ISO 9001  
ISO 13485

## TECHNICAL DETAILS

- 3 sections multi-treatment chair, width 70cm
- Control : Multifonctionnal hand remote
- Backrest and legrest adjustment with electric jacks
- Trendelenburg position
- One section mattress upholstery made of viscoelastic foam , thickness 9cm
- Equipped with 2 stainless steel side rails 25x10 to add accessories, a pushing bar, a footrest and an exam sheet roller on the backrest
- Ergonomic headrest provided in standard
- Shapped base for ideal cleaning, base colour light grey (RAL 7035)
- Central brake system two pedals at the front and a brake bar on the back
- On 4 wheels diam. 150mm

## DIMENSIONS

- Width 70cm, overall width 85cm
- Adjustable height from 56 to 96cm
- Load capacity : 200 kg in dynamic

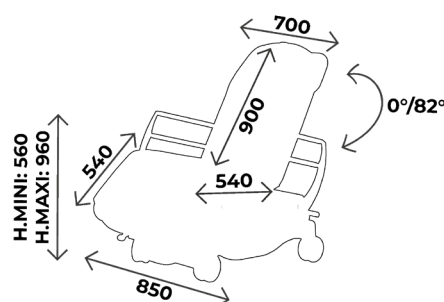

### You may also like :

Ref. **MULT-V2-700** : Same as MULT-V2-700-01 but without footrest

Ref. **MULT-V2-600-01** : Same as MULT-V2-700-01 but width 60cm

Ref. **MULT-V2-600** : Same as MULT-V2-700-01 but width 60cm and without footrest



## WHAT YOU NEED TO KNOW

- ✓ Delivery time: 15 days upon receipt of order
- ✓ Warranty : 5 years (1 year for the upholstery)

**ZOOM**  
MULT-V2-700-01  
with accessories



## ACCESSORIES



### ACC CAPOT

Base colour in a different colour than the standard light grey available in different colours



### RL-150

4 wheels diam. 150mm with central brake system



### ACC MULTIK12

Armrest for MULTV2 chair with fixation clamp to fix on rail dim. 25x10, the unit



### ACC 110POLY

Polyurethane blood test splint without clamp, the unit



### ACC FEMINA02

Pair of stirrups, without clamp



### ACC FEMINA964

Pair of legrests on knee system without clamp



### ACC BATTERIE01

Battery, capacity 20 cycles (1 cycle = 1x height's up/ down + 1x backrest's up/ down)



### ACC MULTIK02

Emergency position button



### ACC CLAMEDIAM16

Adaptation clamp in aluminium for fixation on rail dim. 25x10, the unit diam. 14mm, diam. 16mm



### ACC BARRMULV2-70

Pair of retractable security side rails width 70cm



### ACC OVALIA03

Multifonction pedal



### ACC MULTIK13

Flexible remote holder length 65cm to be fixed on frame with clamp



### ACC MULTIK03

Infusion stand with 2 polyamid hooks equipped with one clamp for fixation on rail dim. 25x10



### ACC MULTIK05

Reading tray, without clamp



### ACC-MULTIKALEDN

Reading lamp with cold light with clamp



### ACC 514-MULTIKA3

Plastic protection width 70cm for legrest

### DEBRAYAGE

Manual disengagement of the backrest

# UPHOLSTERY'S COLOURS

Fire retardant  
upholstery, M1 class

For the upholstery colours, you can choose between the Classic and Urban range  
without extra value

## *Upholstery : Classic range*



Arno



Garonne



Potomac

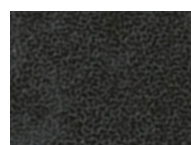

Amour



Mississippi

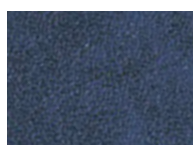

St Laurent



Rhône

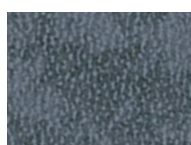

Missouri



Seine

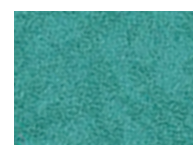

Amazone

## *Upholstery : Urban range*



Abysses



Cendre



Origan



Géranium



Réglisse



Prune

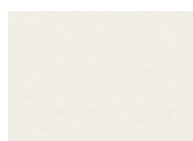

Perle

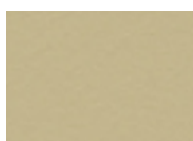

Ficelle

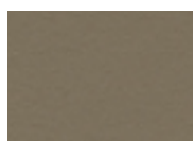

Terre

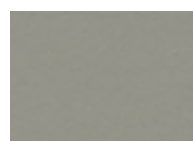

Béton

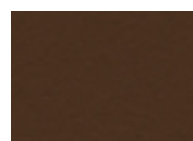

Chataigne

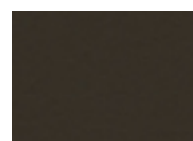

Chocolat



Pensée



Pétrole



Turquoise



Granny



Absinthe



Ananas



Orange



Fuschia



Tomate

## BASE COLOURS

The entire MULTIKA range has a light grey (RAL 7035) cover as standard  
Possibility to change the colour of the cover **with an extra charge (option ACC CAPOT)**

### *Base colour*

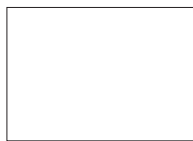

RAL 9003

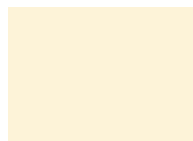

RAL 1013

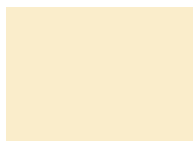

RAL 1015

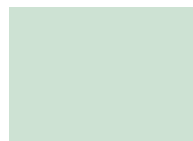

RAL 6019



RAL 6033



RAL 6000



RAL 5017



RAL 5002



RAL 5000

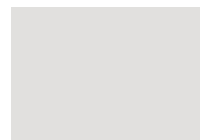

RAL 7035



RAL 7016

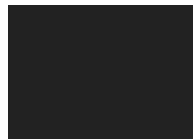

RAL 9005



RAL 1018



RAL 3020



RAL 3003

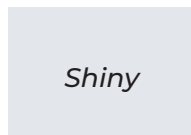

*Shiny*

**SILVER**



# MAINTENANCE GUIDE

## **DAILY MAINTENANCE**

Upholstery : Cleaning with soapy water only (no solvents), can be disinfected with products such as Phagosept Spray, Salvanios pH10 at 0.75% and Anios Surfaces Hautes, without abrasive material

Base : cleaning with soapy water only (no solvents) without abrasive materials

## **WARRANTY**

Mechanical/ electrical part : 5 years

Upholstery : 1 year



**CONTACT**

**CARINA**  
*Médical*

Parc d'entreprises Visionis  
278 rue de l'industrie  
01090 GUÉREINS- FRANCE

**COMMERCIAL DEPARTMENT**

Tél : +33(0)4 74 66 69 49  
Fax : +33(0)4 74 66 69 50  
[export@carinamedical.com](mailto:export@carinamedical.com)