



Fixed height sampling chair

LUVIA range

LUVIA78TSJ

CARINA
Medical



CE
ISO 9001
ISO 13485

TECHNICAL DETAILS

- 2 sections (without legrest) sampling chair with fixed height 51cm
- Backrest adjustment in every positions with gas jack
- Trendelenburg position
- Ergonomic upholstery with good density 35kg/cm², M1 fire retardant class, thickness 7cm. Specially developed for optimal patient comfort
- Equipped with 2 blood test splints, adjustable in every positions with serrated blocks system
- Plastic protection on seat as standard
- Chromed base

DIMENSIONS

- Width 55cm
- Height 51cm
- Load capacity : 130kg

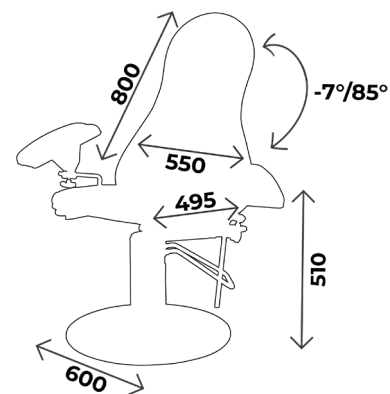

OTHER ELEMENTS

All our chairs can be put in **lying position**

You may also like :

Ref. **LUVIA78T** : Same as LUVIA78TSJ but with legrest



WHAT YOU NEED TO KNOW

- ✓ Delivery time: 15 days upon receipt of order
- ✓ Warranty : 2 years (1 year for the upholstery)

ACCESSORIES



ACC 537LUVIA
Pair of clamps diam. 14mm for blood test splints and stirrups for LUVIA range

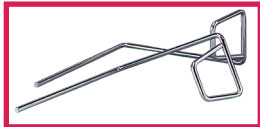

ACC 105
Pair of stainless steel stirrups diam. 14mm, without clamp



SLFEMIREPOSE
Cover for legrests (ACC964) in upholstery, the unit



ACC514-LUVI-ASS
Plastic protection for seatrest

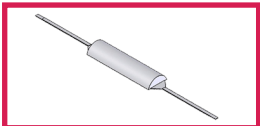

ACC 54005
Half moon head rest width 55cm fire retardant M1 class



ACC 910-PLAT04
Plastic tray 350x270 with clamp



ACC 113U-105
Pair of handles with clamps to fix both handles and stirrups



ACC 32012
Stainless steel infusion stand diam. 16mm, 2 plastic hooks, without clamp



ACC 110
Blood test splint in colour without clamp, the unit

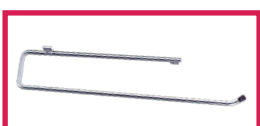

ACC 125
Paper holder for all models



ACC 535
Pair of double clamps diam. 14mm and diam.16mm to fix both armrest and infusion stand



ACC 964
Pair of legrests on knee system in black polyurethane diam. 14mm, without clamp



ACC 514-GOUT
Plastic protection for blood test splint, the unit

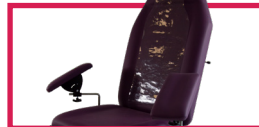

ACC514-LUVI-DOS
Plastic protection for backrest



ACC 910-PLAT02
Stainless steel tray 340x340 with clamp



ACC 113U
Pair of handles without clamp with U shape



ACC TETERGO-LUV
Tête ergonomique amovible pour gamme LUVIA



ACC 32014
Stainless steel infusion stand diam. 16mm, 2 stainless steel hooks without clamp



ACC 110POLY
Polyurethane blood test splint without clamp, the unit

UPHOLSTERY'S COLOURS

Fire retardant upholstery, M1 class

For the upholstery colours, you can choose between the Classic and Urban range
Be careful ! Urban colours **with extra value**

Upholstery : Classic range



Arno



Garonne



Potomac

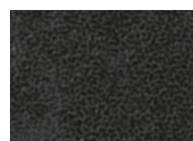

Amour



Mississippi

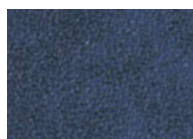

St Laurent



Rhône

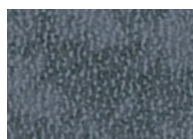

Missouri



Seine

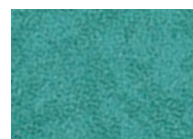

Amazone

Upholstery : Urban range



Abysses



Cendre



Origan



Géranium



Réglisse



Prune

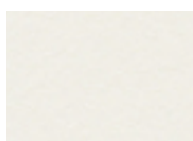

Perle

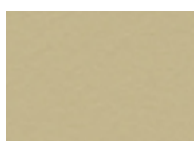

Ficelle

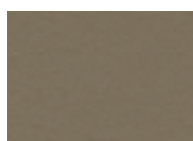

Terre

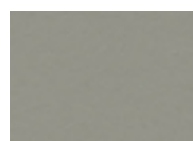

Béton

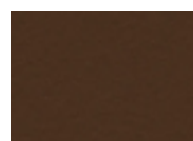

Chataigne



Chocolat



Pensée



Pétrole



Turquoise



Granny



Absinthe



Ananas



Orange



Fuschia



Tomate



MAINTENANCE GUIDE

DAILY MAINTENANCE

Upholstery : Cleaning with soapy water only (no solvents), can be disinfected with products such as Phagosept Spray, Salvanios pH10 at 0.75% and Anios Surfaces Hautes, without abrasive material

Base : cleaning with soapy water only (no solvents) without abrasive materials

WARRANTY

Mechanical/ electrical part : 2 years

Upholstery : 1 year

CONTACT

CARINA
Médical

Parc d'entreprises Visionis
278 rue de l'industrie
01090 GUÉREINS- FRANCE

COMMERCIAL DEPARTMENT

Tél : +33(0)4 74 66 69 49
Fax : +33(0)4 74 66 69 50
export@carinamedical.com