



*ECOMAX pack*  
*ECOMAX range*  
**ENSECOMAX**

**CARINA**  
*Medical*



**CE**  
ISO 9001  
ISO 13485

## TECHNICAL DETAILS

### 1X ECOMAX

- 2 sections examination couch, width 60cm
- Adjustable backrest with 2 indexable racks
- Flat upholstery with good density 24kg/m<sup>2</sup>, M1 fire retardant class, thickness 6cm
- Equipped with paper roll holder : possibility to fix it on foot or head side
- Epoxy covering, silver colour
- Load capacity : 150kg
- Delivered disassembled with instructions

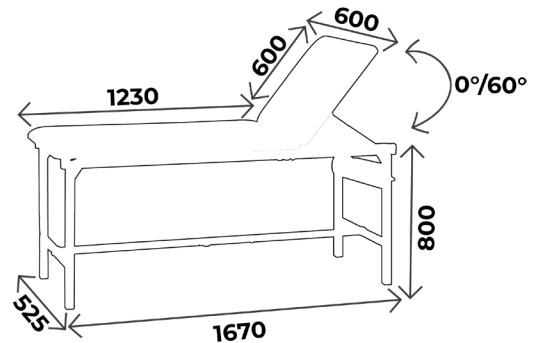

### 1X 24301

- 2 white laminated trays trolley 60x40cm
- Equipped with 4 wheels diam. 50mm
- Epoxy covering
- Delivered disassembled with key and instructions

### 1X ECOMAXMARI

- Step tool 1 step
- Step in black ABS
- Epoxy covering, silver colour

### 1X PRISCA/ONE

- Standard stool
- Adjustable height from 50 to 70cm
- Round seat diam. 35cm
- Fire retardant upholstery M2 class, thickness 6cm
- 5 black ABS branches base diam. 55cm

#### You may also like :

Ref. **ENSECOMAX-01** : Same as ENSECOMAX but without trolley 24301

Ref. **ENSECOMAX-700** : Same as ENSECOMAX but with ECOMAX width 70cm

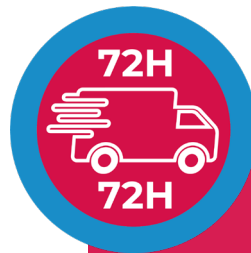

## WHAT YOU NEED TO KNOW

- ✓ Warranty : 5 years (1 year for the upholstery)

## COUCH'S ACCESSORIES



**ACC 538D16**  
Pair of clamps diam. 16mm for  
ECOMAX range width 60cm



**ACC 538**  
Pair of clamps diam. 14mm  
for ECOMAX range width 60cm



**ACC 76C**  
Unit clamp to fix infusion stand  
diam. 16mm



**ACC 32012**  
Stainless steel infusion stand  
diam. 16mm, 2 plastic hooks,  
without clamp



**ACC 110**  
Blood test splint in colour  
without clamp, the unit



**ACC 110POLY**  
Polyurethane blood test splint  
without clamp, the unit

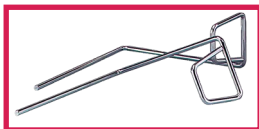

**ACC 105**  
Pair of stainless steel  
stirrups diam. 14mm,  
without clamp



**ACC 964**  
Pair of legrests on knee system  
in black polyurethane  
diam. 14mm, without clamp



**SLFEMIREPOSE**  
Cover for legrests (ACC964)  
in upholstery, the unit



**ACC 514-UNIVERSE**  
Plastic protection cover  
for all couches



**ACC TETERGO**  
Ergonomic head rest

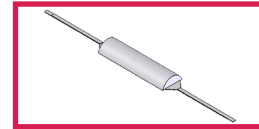

**ACC 54001**  
Half moon head rest width  
60cm fire retardant M1 class



**ACC 832**  
Face hole with plug cushion



**ACC URGENCE03-60**  
Pair of retractable security side  
rails for ECOMAX couch  
width 60cm



**ACC 990**  
Set of 4 wheels with brake  
diam. 125mm

# UPHOLSTERY'S COLOURS

Fire retardant  
upholstery, M2 class

For the upholstery colours, you can choose between the Ecomax, Classic and Urban range  
Be careful ! Classic and Urban colours **with extra value**

## *Upholstery : ECOMAX\* range*



Galapagos



Bahamas

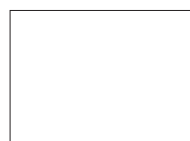

Blanc



Tahiti



Malouines

\*Standard colors for ECOMAX and SIMPLEX range,  
Classic and Urban colors available **on demand**



# UPHOLSTERY'S COLOURS

Fire retardant  
upholstery, M1 class

For the upholstery colours, you can choose between the Classic and Urban range  
Be careful ! Classic and Urban colours **with extra value**

## *Upholstery : Classic range*



Arno



Garonne



Potomac

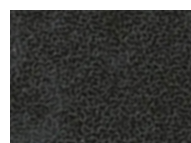

Amour



Mississippi

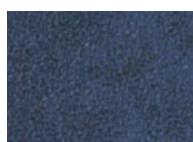

St Laurent



Rhône

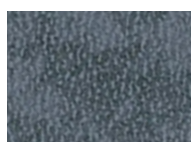

Missouri



Seine

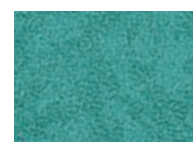

Amazone

## *Upholstery : Urban range*



Abysses



Cendre



Origan



Géranium



Réglisse



Prune

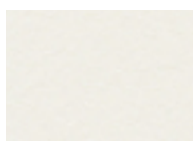

Perle

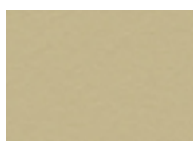

Ficelle

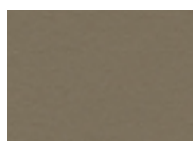

Terre

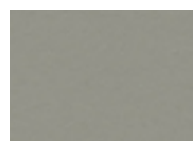

Béton

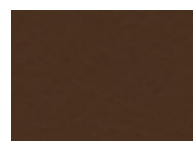

Chataigne

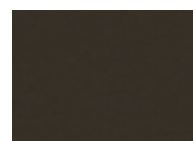

Chocolat

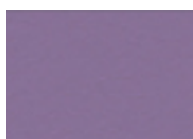

Pensée



Pétrole



Turquoise



Granny



Absinthe



Ananas



Orange



Fuschia



Tomate



# MAINTENANCE GUIDE

## **DAILY MAINTENANCE**

Upholstery : Cleaning with soapy water only (no solvents), can be disinfected with products such as Phagosept Spray, Salvanios pH10 at 0.75% and Anios Surfaces Hautes, without abrasive material

Base : cleaning with soapy water only (no solvents) without abrasive materials

## **WARRANTY**

Mechanical/ electrical part : 5 years

Upholstery : 1 year



**CONTACT**

**CARINA**  
*Médical*

Parc d'entreprises Visionis  
278 rue de l'industrie  
01090 GUÉREINS- FRANCE

**COMMERCIAL DEPARTMENT**

Tél : +33(0)4 74 66 69 49  
Fax : +33(0)4 74 66 69 50  
[export@carinamedical.com](mailto:export@carinamedical.com)