



Fixed height examination couch

326 range

326 01TB

CARINA
Medical



CE
ISO 9001
ISO 13485

TECHNICAL DETAILS

- 2 sections examination couch, width 60cm
- Adjustable backrest with gas jack
- Upholstery without visible seam with good density 30kg/cm², M1 fire retardant class, thickness 8cm
- Equipped with paper roll holder for exam sheet, on the foot side
- Epoxy covering, light grey colour (RAL 7035) in standard

DIMENSIONS

- Width 60cm
- Height 65cm
- Load capacity : 130kg

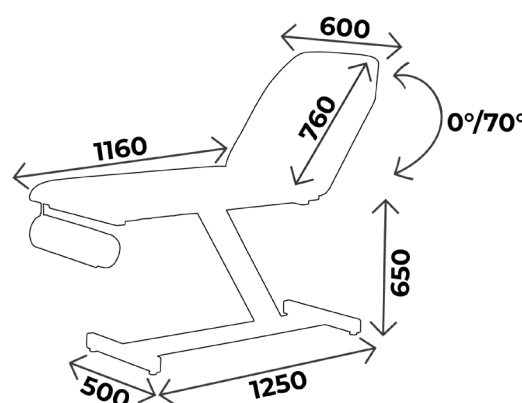

You may also like :

Ref. **326 01T** : Same as 326 01TB but height 80cm

Ref. **326 03TB** : Same as 326 01TB but width 70cm

Ref. **326 03T** : Same as 326 01TB but width 70cm and height 80cm



WHAT YOU NEED TO KNOW

- ✓ Delivery time: 15 days upon receipt of order
- ✓ Warranty : 5 years (1 year for the upholstery)

ACCESSORIES



ACC 999
4 retractable wheels diam. 50mm
for 326 fixed height adjustment
range



ACC 990
Set of 4 wheels with brake
diam. 125mm



ACC 76B
Unit clamp to fix infusion stand
diam. 14mm



ACC 76
Pair of clamps to fix blood test
splint and stirrups diam. 14mm



ACC 76C
Unit clamp to fix infusion stand
diam. 16mm



ACC 32012
Stainless steel infusion stand
diam. 16mm, 2 plastic hooks,
without clamp

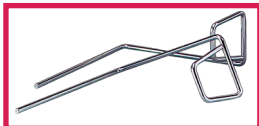

ACC 105
Pair of stainless steel
stirrups diam. 14mm
without clamp



ACC 964
Pair of legrests on knee system
in black polyurethane,
diam. 14 mm, without clamp



SLFEMIREPOSE
Cover for legrests ACC964
in upholstery, the unit



ACC 514-UNIVERSE
Plastic protection cover
for all couches



ACC 110POLY
Polyurethane blood test splint
without clamp, the unit



ACC 110
Blood test splint in colour
without clamp, the unit

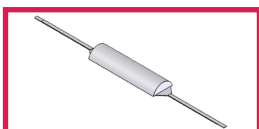

ACC 32660
Half moon headrest width 60cm
fire retardant M1 class



ACC TETERGO
Ergonomic headrest



ACC 832
Face hole with plug cushion



ACC BARRILIT326A
Pair of retractable security side
rails for 326, 2 sections

UPHOLSTERY'S COLOURS

Fire retardant
upholstery, M1 class

For the upholstery colours, you can choose between the Classic and Urban range
Be careful ! Urban colours **with extra value**

Upholstery : Classic range

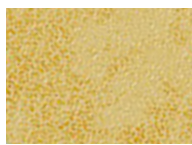

Arno

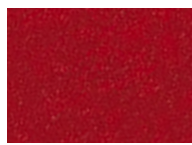

Garonne



Potomac



Amour

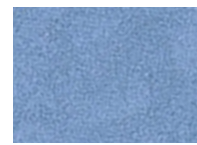

Mississippi

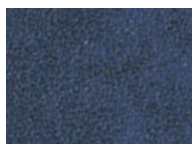

St Laurent



Rhône

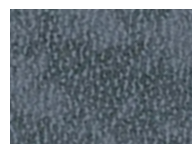

Missouri



Seine

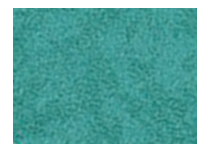

Amazone

Upholstery : Urban range



Abysses



Cendre



Origan



Géranium



Réglisse



Prune

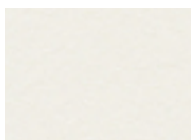

Perle

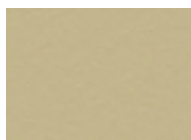

Ficelle

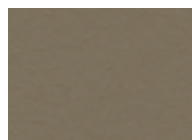

Terre



Béton

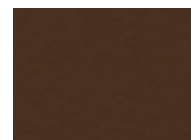

Chataigne

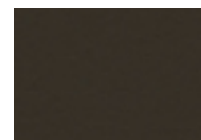

Chocolat

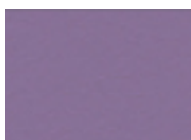

Pensée



Pétrole



Turquoise



Granny



Absinthe



Ananas



Orange



Fuschia





Tomate



BASE COLOURS

The entire 326 range is offered in light grey (RAL 7035) as standard
Possibility to change the color without extra charge

Base colour

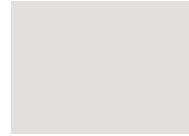
				
RAL 9003	RAL 1013	RAL 1015	RAL 6019	RAL 6033
				
RAL 6000	RAL 5017	RAL 5002	RAL 5000	RAL 7035
				
RAL 7016	RAL 9005	RAL 1018	RAL 3020	RAL 3003
				
		<i>Shiny</i>		
		SILVER		



MAINTENANCE GUIDE

DAILY MAINTENANCE

Upholstery : Cleaning with soapy water only (no solvents), can be disinfected with products such as Phagosept Spray, Salvanios pH10 at 0.75% and Anios Surfaces Hautes, without abrasive material

Base : cleaning with soapy water only (no solvents) without abrasive materials

WARRANTY

Mechanical/ electrical part : 5 years

Upholstery : 1 year



CONTACT

CARINA
Médical

Parc d'entreprises Visionis
278 rue de l'industrie
01090 GUÉREINS- FRANCE

COMMERCIAL DEPARTMENT

Tél : +33(0)4 74 66 69 49
Fax : +33(0)4 74 66 69 50
export@carinamedical.com