



Fixed height gynaecological chair

625 range

625 01T

CARINA
Medical



CE
ISO 9001
ISO 13485

TECHNICAL DETAILS

- 2 sections gynaecological chair, width 60cm
- Backrest adjustment with gas jack
- Trendelenburg position
- Flat upholstery with good density 30kg/cm², M1 fire retardant class, thickness 8cm
- Equipped with a stainless steel drawer, a pair of clamps and a pair of stirrups
- With paper roll holder for exam sheet, on the head side
- Epoxy covering, light grey colour (RAL 7035) in standard

DIMENSIONS

- Width 60cm
- Adjustable height from 62 to 92cm
- Load capacity : 130kg

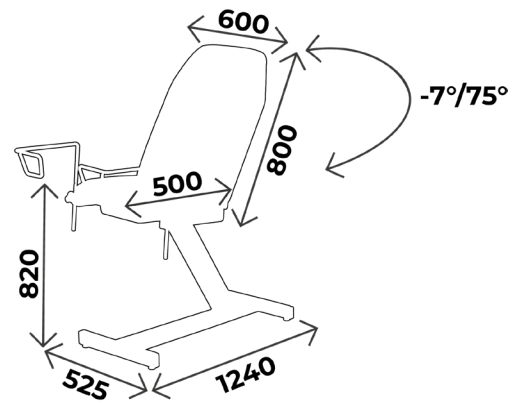

You may also like :

Ref. **625 01T+964** : Same as 625 01T but with a pair of legrests

Ref. **625 02T** : Same as 625 01T but 3 sections

Ref. **625 02T+964** : Same as 625 01T but 3 sections and with a pair of legrests



WHAT YOU NEED TO KNOW

- ✓ Delivery time: 15 days upon receipt of order
- ✓ Warranty : 5 years (1 year for the upholstery)

ACCESSORIES



ACC 964
Pair of legrests on knee system
in black polyurethane,
diam. 14 mm, without clamp



ACC TETERGO
Ergonomic head rest

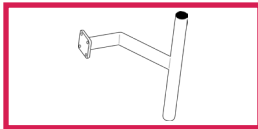

ACC 63
Coloscope holder



ACC 537
Pair of clamps diam. 14mm for
blood test splints and stirrups
for 625 and 725 range



SLFEMIREPOSE
Cover for legrests (ACC964) in
upholstery, the unit

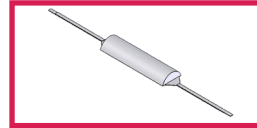

ACC 54004
Half moon head rest width 60cm
fire retardant M1 class
for 625 range

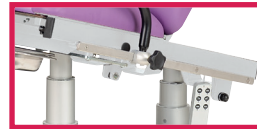

ACC RAIL IN-L400
Pair of stainless steel rails dim.
25x10 length 40cm for seatrest
of range 625, 725 and 524



ACC 110
Blood test splint in colour
without clamp, the unit

UPHOLSTERY'S COLOURS

Fire retardant
upholstery, M1 class

For the upholstery colours, you can choose between the Classic and Urban range
Be careful ! Urban colours **with extra value**

Upholstery : Classic range



Arno



Garonne



Potomac

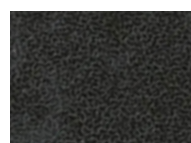

Amour

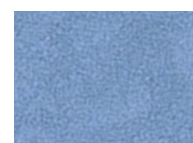

Mississippi



St Laurent



Rhône



Missouri



Seine

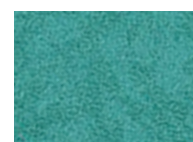

Amazone

Upholstery : Urban range



Abysse

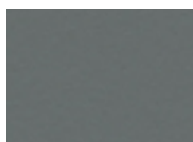

Cendre



Origan

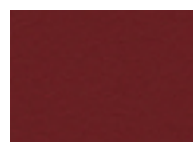

Géranium



Réglisse



Prune

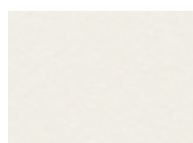

Perle

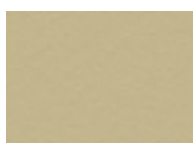

Ficelle

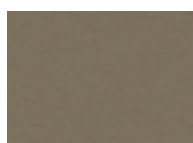

Terre

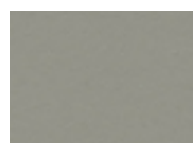

Béton

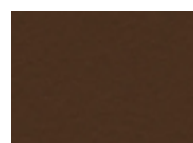

Chataigne

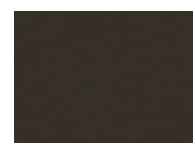

Chocolat



Pensée



Pétrole



Turquoise



Granny



Absinthe



Ananas



Orange



Fuschia



Tomate



BASE COLOURS

The entire 625 range is offered in light grey (RAL 7035) as standard
Possibility to change the color without extra charge

Base colour



RAL 9003

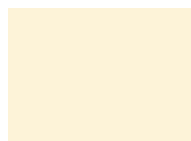

RAL 1013

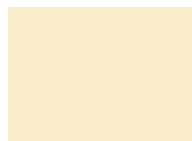

RAL 1015

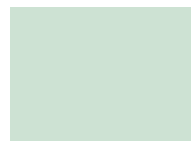

RAL 6019



RAL 6033



RAL 6000



RAL 5017



RAL 5002



RAL 5000

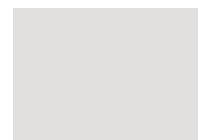

RAL 7035



RAL 7016

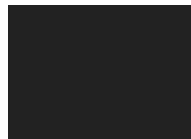

RAL 9005



RAL 1018



RAL 3020



RAL 3003

Shiny

SILVER



MAINTENANCE GUIDE

DAILY MAINTENANCE

Upholstery : Cleaning with soapy water only (no solvents), can be disinfected with products such as Phagosept Spray, Salvanios pH10 at 0.75% and Anios Surfaces Hautes, without abrasive material

Base : cleaning with soapy water only (no solvents) without abrasive materials

WARRANTY

Mechanical/ electrical part : 5 years

Upholstery : 1 year



CONTACT

CARINA
Médical

Parc d'entreprises Visionis
278 rue de l'industrie
01090 GUÉREINS- FRANCE

COMMERCIAL DEPARTMENT

Tél: +33(0)4 74 66 69 49
Fax: +33(0)4 74 66 69 50
export@carinamedical.com