



Electric gynaecological chair

625 range

625 04T

CARINA
Medical



CE
ISO 9001
ISO 13485

TECHNICAL DETAILS

- 3 sections gynaecological chair, width 60cm
- Control : Pedal
- Backrest adjustment with gas jack
- Trendelenburg position
- Flat upholstery with good density 30kg/cm², M1 fire retardant class, thickness 8cm
- Equipped with a stainless steel drawer, a pair of clamps and a pair of stirrups
- With paper roll holder for exam sheet, on the head side
- Epoxy covering, light grey colour (RAL 7035) in standard

DIMENSIONS

- Width 60cm
- Adjustable height from 62 to 92cm
- Load capacity : 150kg

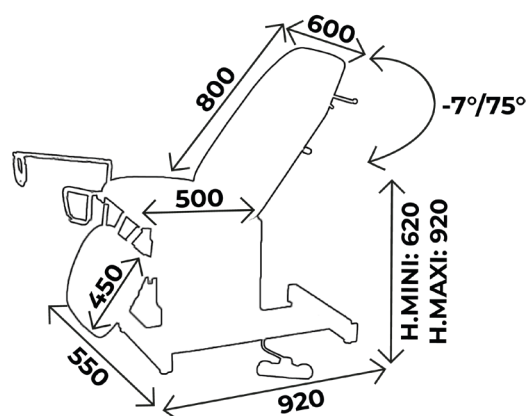

You may also like :

Ref. **625 03T**: Same as 625 04T but 2 sections



WHAT YOU NEED TO KNOW

- ✓ Delivery time: 15 days upon receipt of order
- ✓ Warranty : 5 years (1 year for the upholstery)

ACCESSORIES



ACC 964
Pair of legrests on knee system in black polyurethane, diam. 14 mm, without clamp



ACC TETERGO
Ergonomic head rest

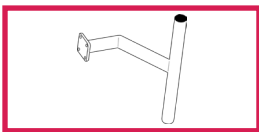

ACC 63
Coloscope holder



ACC 537
Pair of clamps diam. 14mm for blood test splints and stirrups for 625 and 725 range

ACC 62524
Electric backrest for 625 electric height adjustment range



ACC 997
4 retractable wheels diam. 50mm for 625 electric height adjustment range



SLFEMIREPOSE
Cover for legrests (ACC964) in upholstery, the unit

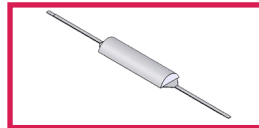

ACC 54004
Half moon head rest width 60cm fire retardant M1 class for 625 range

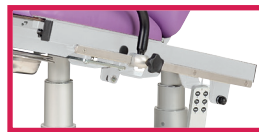

ACC RAIL IN-L400
Pair of stainless steel rails dim. 25x10 length 40cm for seatrest of range 625, 725 and 524



ACC 110
Blood test splint in colour without clamp, the unit

ACC 62525
Electric legrest for 625 electric height adjustment range

UPHOLSTERY'S COLOURS

Fire retardant upholstery, M1 class

For the upholstery colours, you can choose between the Classic and Urban range
Be careful ! Urban colours **with extra value**

Upholstery : Classic range



Upholstery : Urban range





BASE COLOURS

The entire 625 range is offered in light grey (RAL 7035) as standard
Possibility to change the color without extra charge

Base colour



RAL 9003

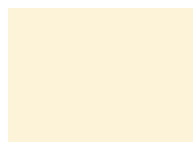

RAL 1013

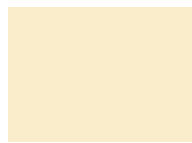

RAL 1015

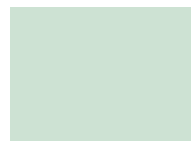

RAL 6019



RAL 6033



RAL 6000



RAL 5017



RAL 5002



RAL 5000

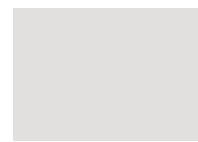

RAL 7035



RAL 7016

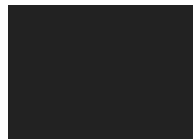

RAL 9005



RAL 1018



RAL 3020



RAL 3003

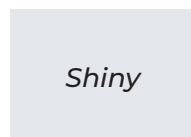

Shiny

SILVER



MAINTENANCE GUIDE

DAILY MAINTENANCE

Upholstery : Cleaning with soapy water only (no solvents), can be disinfected with products such as Phagosept Spray, Salvanios pH10 at 0.75% and Anios Surfaces Hautes, without abrasive material

Base : cleaning with soapy water only (no solvents) without abrasive materials

WARRANTY

Mechanical/ electrical part : 5 years

Upholstery : 1 year



CONTACT

CARINA
Médical

Parc d'entreprises Visionis
278 rue de l'industrie
01090 GUÉREINS- FRANCE

COMMERCIAL DEPARTMENT

Tél: +33(0)4 74 66 69 49
Fax: +33(0)4 74 66 69 50
export@carinamedical.com