



Fauteuil de prélèvement hydraulique
Gamme LUVIA
LUVIA05T-GYNECO

CARINA
Medical



CE
ISO 9001
ISO 13485

DESCRIPTION TECHNIQUE

- Fauteuil de prélèvement à hauteur variable hydraulique pivotant à 360° (possibilité de bloquer la rotation), 3 parties
- Dossier et jambière réglables par vérins à gaz indépendants
- La jambière peut être mise en position verticale
- Position de Trendelenburg
- Sellerie en forme ergonomique de bonne densité 35kg/cm², non-feu classée M1, épaisseur 7cm. Spécialement développée pour un confort optimum du patient
- Equipé d'une paire de gouttières prise de sang réglables en toutes positions par systèmes mécaniques sécurisés et indexables, d'une paire d'étaux et d'étriers pour prélèvements gynécologiques
- Protection plastique sur assise et jambière en standard
- Piètement acier peint époxy, coloris gris clair (RAL 7035) en standard

DIMENSIONS

- Largeur 55cm
- Hauteur variable de 56cm à 75cm
- Capacité de charge : 130kg en dynamique

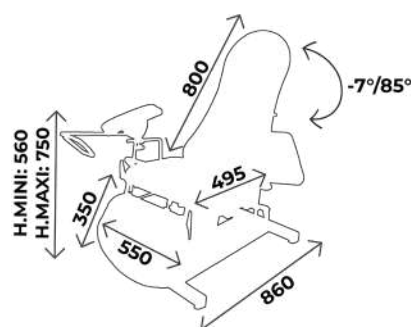

À NOTER

Tous nos fauteuils peuvent être mis en **position allongée**



À SAVOIR

- ✓ Délai : 15 jours à réception commande
- ✓ Garantie : 2 ans (1 an pour la sellerie)

ACCESSOIRES



ACC 537
Jeu d'étaux diam. 14mm
pour gouttières



ACC 105
Jeu d'étriers inox standard
diam. 14mm, sans étau



SLFEMIREPOSE
Housse prélude pour repose
jambes (ACC964), l'unité



ACC514-LUVI-ASS
Protection plastique assise



ACC514-LUVI-DOS
Protection plastique pour dossier



ACC 910-PLAT02
Plateau inox support 340x340
avec étau



ACC 113U
Jeu de poignées de maintien
latérales, sans étau prêt à fixer
sur fauteuil



ACC 535
Jeu d'étaux double diam. 14mm
et 16mm pour gouttière + tige
porte-sérum



ACC 32014
Tige porte-sérum inox diam.
16mm, 2 crochets inox,
sans étau



ACC 110
Gouttière prise de sang
Avec ferrure, sans étau, l'unité
* Disponible en polyuréthane avec
option ACC 110POLY



ACC 993
Support roulettes escamotables
diam. 50mm



ACC 537LUVIA
Jeu d'étaux diam. 14mm
pour étriers pour gamme LUVIA



ACC 964
Jeu de repose jambes noir,
sur rotule mousse polyuréthane,
diam. 14mm, sans étau



ACC 514-GOUT
Protection gouttière en plastique
transparent, l'unité



ACC514-LUVI-JAM
Protection plastique pour
jambière



ACC 54005
Têteière 1/2 lune largeur 55cm
revêtement non feu M1



ACC 910-PLAT04
Plateau plastique
support 350x270 avec étau



ACC 113U-105
Jeu de poignées de maintien
latérales, avec étaux pour
adapter une paire d'étriers
prêt à fixer sur fauteuil



ACC 32012
Tige porte-sérum inox diam.
16mm, 2 crochets plastiques,
sans étau



ACC TETERGO-LUV
Têteière ergonomique amovible
pour gamme LUVIA

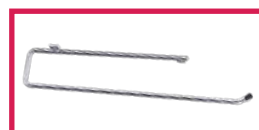

ACC 125
Porte rouleau
adaptable tous modèles



ACC 9505
Jeu de 4 roulettes diam. 50mm
avec frein

COLORIS SELLERIE

Sellerie non-feu
classée M1

Pour les coloris de sellerie, vous avez le choix entre la gamme Classique et Urban
Attention ! coloris Urban **avec plus value**

Revêtement : Sellerie Gamme Classique



Arno



Garonne



Potomac

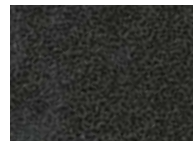

Amour



Mississippi

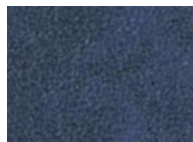

St Laurent

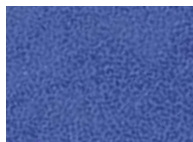

Rhône



Missouri



Seine



Amazone

Revêtement : Sellerie Gamme Urban



Abysse

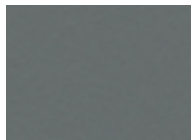

Cendre



Origan



Géranium



Réglisse



Prune

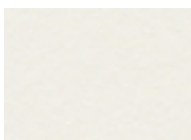

Perle

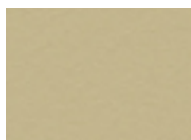

Ficelle

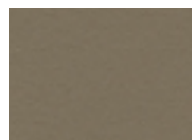

Terre

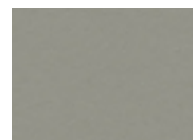

Béton

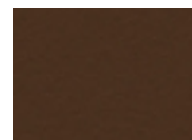

Chataigne

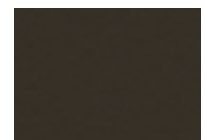

Chocolat

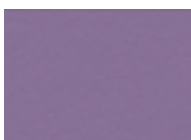

Pensée



Pétrole



Turquoise



Granny



Absinthe



Ananas



Orange



Fuschia



Tomate

COLORIS PIÈTEMENT

Le fauteuil LUVIA05T-GYNECO est proposé en coloris (RAL 7035) en standard
Possibilité de changer le coloris de piètement **sans plus value**

Piètement Peinture EPOXY



RAL 9003

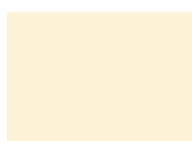

RAL 1013

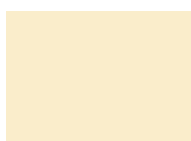

RAL 1015



RAL 6019



RAL 6033



RAL 6000



RAL 5017



RAL 5002



RAL 5000



RAL 7035



RAL 7016



RAL 9005



RAL 1018



RAL 3020



RAL 3003

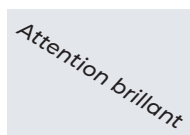

ARGENT



GUIDE D'ENTRETIEN

ENTRETIEN QUOTIDIEN

- Sellerie : nettoyage à l'eau savonneuse uniquement (solvants proscrits), peut être désinfecté avec des produits tels que Phagosept Spray, Salvanios pH10 à 0,75% et Anios Surfaces Hautes, sans matière abrasive
- Piètement : nettoyage à l'eau savonneuse uniquement (solvants proscrits) sans matière abrasive

GARANTIE

- Châssis : 2 ans
- Sellerie : 1 an



CONTACT

CARINA
Médical

Parc d'entreprises Visionis
278 rue de l'industrie
01090 GUÉREINS- FRANCE

SERVICE COMMERCIAL

Tél : +33(0)4 74 66 69 49
Fax : +33(0)4 74 66 69 50
commercial@carinamedical.com