



*Divan d'examen hauteur fixe*

**Gamme 124**

**124 21HB**

**CARINA**  
*Medical*



**CE**  
ISO 9001  
ISO 13485

## DESCRIPTION TECHNIQUE

- Divan d'examen à hauteur fixe, 2 parties
- Réglage de la tête par système mécanique
- Sellerie avec couture apparente, de bonne densité 30kg/cm<sup>2</sup>, non-feu classée M1, épaisseur 8cm
- Equipé d'un porte-rouleau pour drap d'examen côté pied
- Piètement acier peint époxy, coloris gris clair (RAL 7035) en standard

## DIMENSIONS

- Largeur 80cm
- Hauteur 65cm
- Capacité de charge : 150kg

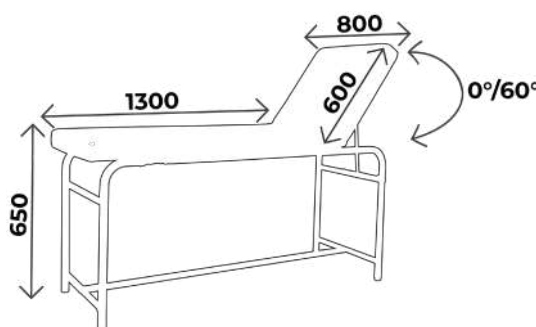

### Vous aimerez aussi :

Réf. **124 21** : Idem 124 21HB mais hauteur 80cm

Réf. **124 20HB** : Idem 124 21HB mais largeur 70cm

Réf. **124 20** : Idem 124 21HB mais largeur 70cm et hauteur 80cm

Réf. **124 25HB** : Idem 124 21HB largeur 70cm et capacité de charge 200kg

Réf. **124 25** : Idem 124 21HB mais largeur 70cm et hauteur 80cm et capacité de charge 200kg

Réf. **124 19HB** : Idem 124 21HB mais largeur 60cm

Réf. **124 19** : Idem 124 21HB mais largeur 60cm et hauteur 80cm



### À SAVOIR

- ✓ Délai : 15 jours à réception commande
- ✓ Garantie : 5 ans (1 an pour la sellerie)

## ACCESSOIRES



**ACC 75**  
Jeu d'étaux diam. 14mm



**ACC 75A**  
Etau unitaire diam. 14mm



**ACC 76C**  
Etau unitaire  
pour tige porte-sérum diam. 16mm



**ACC 32012**  
Tige porte-sérum diam. 16mm  
2 crochets plastiques, sans étau



**ACC 110**  
Gouttière prise de sang  
Avec ferrure, sans étau, l'unité



**ACC 110POLY**  
Gouttière prise de sang  
polyuréthane avec ferrure  
Sans étau, l'unité

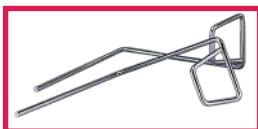

**ACC 105**  
Jeu d'étriers inox standard  
diam. 14mm, sans étau



**ACC 964**  
Jeu de repose jambes noir,  
sur rotule mousse polyuréthane,  
diam. 14mm, sans étau



**SLFEMIREPOSE**  
Housse prélude pour repose  
jambes (ACC964), l'unité



**ACC 514-UNIVERSE**  
Protection plastique transparent  
universelle



**ACC TETERGO**  
Tête ergonomique amovible



**ACC 54003**  
Tête 1/2 lune largeur 80cm  
revêtement non M1

# COLORIS SELLERIE

Sellerie non-feu  
classée M1

Pour les coloris de sellerie, vous avez le choix entre la gamme Classique et Urban  
Attention ! coloris Urban **avec plus value**

## *Revêtement : Sellerie Gamme Classique*



Arno



Garonne



Potomac



Amour



Mississippi



St Laurent

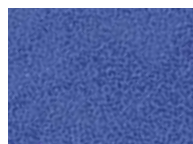

Rhône

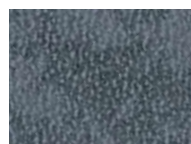

Missouri



Seine



Amazone

## *Revêtement : Sellerie Gamme Urban*



Abysse

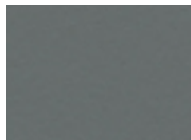

Cendre



Origan



Géranium

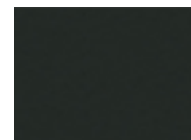

Réglisse



Prune

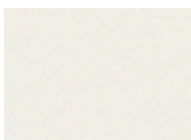

Perle

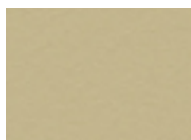

Ficelle

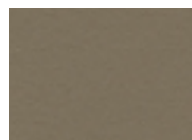

Terre

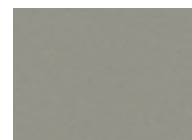

Béton

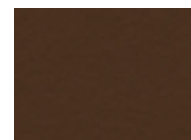

Chataigne

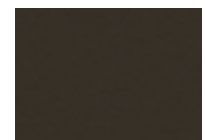

Chocolat

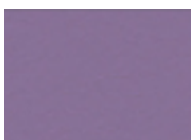

Pensée



Pétrole



Turquoise



Granny



Absinthe



Ananas



Orange



Fuschia



Tomate

# COLORIS PIÈTEMENT

Toute la gamme 124 est proposée en coloris (RAL 7035) en standard  
Possibilité de changer le coloris de piètement **sans plus value**

## *Piètement Peinture EPOXY*

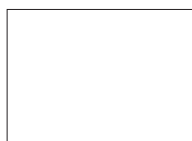

RAL 9003

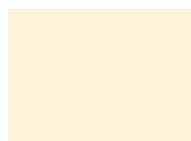

RAL 1013

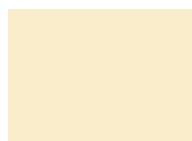

RAL 1015

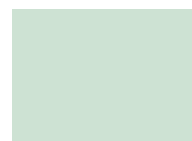

RAL 6019



RAL 6033



RAL 6000



RAL 5017



RAL 5002



RAL 5000



RAL 7035



RAL 7016

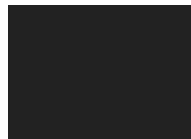

RAL 9005



RAL 1018



RAL 3020



RAL 3003

*Attention brillant*

**ARGENT**



## GUIDE D'ENTRETIEN

### ENTRETIEN QUOTIDIEN

- Sellerie : nettoyage à l'eau savonneuse uniquement (solvants proscrits), peut être désinfecté avec des produits tels que Phagosept Spray, Salvanios pH10 à 0,75% et Anios Surfaces Hautes, sans matière abrasive
- Piètement : nettoyage à l'eau savonneuse uniquement (solvants proscrits) sans matière abrasive

### GARANTIE

- Châssis : 5 ans
- Sellerie : 1 an



**CONTACT**

**CARINA**  
*Médical*

Parc d'entreprises Visionis  
278 rue de l'industrie  
01090 GUÉREINS- FRANCE

**SERVICE COMMERCIAL**

Tél : +33(0)4 74 66 69 49  
Fax : +33(0)4 74 66 69 50  
[commercial@carinamedical.com](mailto:commercial@carinamedical.com)