



Divan d'examen hauteur fixe

Gamme 124

124 19

CARINA
Medical



CE
ISO 9001
ISO 13485

DESCRIPTION TECHNIQUE

- Divan d'examen à hauteur fixe, 2 parties
- Réglage de la tête par système mécanique
- Sellerie avec couture apparente de bonne densité 30kg/cm², non-feu classée M1, épaisseur 8cm
- Equipé d'un porte-rouleau pour drap d'examen côté pied
- Piètement acier peint époxy, coloris gris clair (RAL 7035) en standard

DIMENSIONS

- Largeur 60cm
- Hauteur 80cm
- Capacité de charge : 150kg

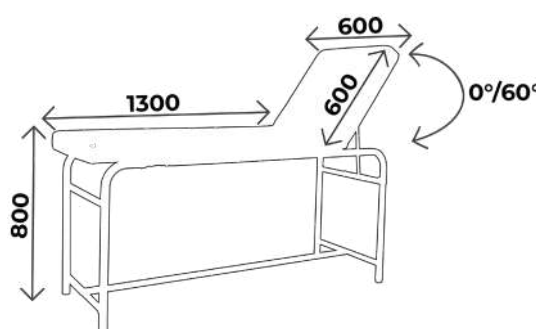

Vous aimerez aussi :

Réf. **124 19HB** : Idem 124 19 mais hauteur 65cm

Réf. **124 20** : Idem 124 19 mais largeur 70cm

Réf. **124 20HB** : Idem 124 19 mais largeur 70cm et hauteur 65cm

Réf. **124 21** : Idem 124 19 mais largeur 80cm

Réf. **124 21HB** : Idem 124 19 mais largeur 80cm et hauteur 65cm

Réf. **124 25** : Idem 124 19 mais largeur 70cm et capacité de charge 200kg

Réf. **124 25HB** : Idem 124 19 mais largeur 70cm et hauteur 65cm et capacité de charge 200kg



À SAVOIR

- ✓ Délai : 15 jours à réception commande
- ✓ Garantie : 5 ans (1 an pour la sellerie)

ACCESSOIRES



ACC 75
Jeu d'étaux diam. 14mm



ACC 75A
Etau unitaire diam. 14mm



ACC 76C
Etau unitaire
pour tige porte-sérum diam. 16mm



ACC 32012
Tige porte-sérum diam. 16mm
2 crochets plastiques, sans étau



ACC 110
Gouttière prise de sang
Avec ferrure, sans étau, l'unité



ACC 110POLY
Gouttière prise de sang
polyuréthane avec ferrure
Sans étau, l'unité



ACC 105
Jeu d'étriers inox standard
diam. 14mm, sans étau



ACC 964
Jeu de repose jambes noir,
sur rotule mousse polyuréthane,
diam. 14mm, sans étau



SLFEMIREPOSE
Housse prélude pour repose
jambes (ACC964), l'unité



ACC 514-UNIVERSE
Protection plastique transparent
universelle



ACC TETERGO
Tête ergonomique amovible



ACC 54001
Tête 1/2 lune largeur 60cm
revêtement non M1

COLORIS SELLERIE

Sellerie non-feu
classée M1

Pour les coloris de sellerie, vous avez le choix entre la gamme Classique et Urban
Attention ! coloris Urban avec plus value

Revêtement : Sellerie Gamme Classique



Arno



Garonne



Potomac



Amour

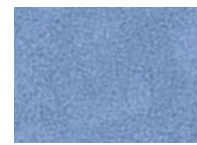

Mississippi

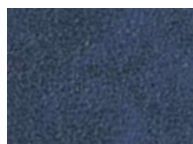

St Laurent

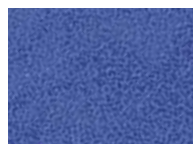

Rhône

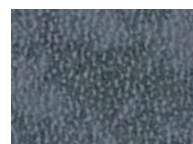

Missouri



Seine



Amazone

Revêtement : Sellerie Gamme Urban



Abysse

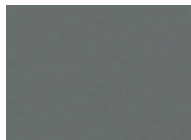

Cendre



Origan



Géranium

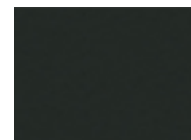

Réglisse



Prune

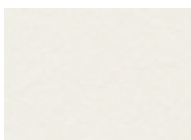

Perle

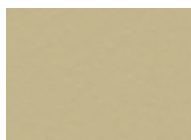

Ficelle

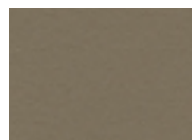

Terre

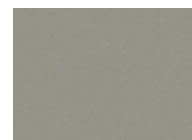

Béton

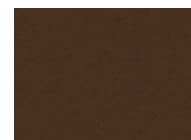

Chataigne

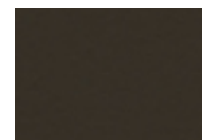

Chocolat



Pensée



Pétrole



Turquoise



Granny



Absinthe



Ananas



Orange



Fuschia



Tomate

COLORIS PIÈTEMENT

Toute la gamme 124 est proposée en coloris (RAL 7035) en standard
Possibilité de changer le coloris de piètement **sans plus value**

Piètement Peinture EPOXY



RAL 9003

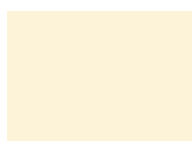

RAL 1013

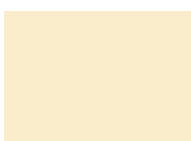

RAL 1015



RAL 6019



RAL 6033



RAL 6000



RAL 5017



RAL 5002



RAL 5000



RAL 7035



RAL 7016



RAL 9005



RAL 1018



RAL 3020



RAL 3003

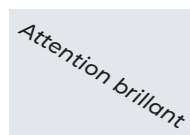

ARGENT



GUIDE D'ENTRETIEN

ENTRETIEN QUOTIDIEN

- Sellerie : nettoyage à l'eau savonneuse uniquement (solvants proscrits), peut être désinfecté avec des produits tels que Phagosept Spray, Salvanios pH10 à 0,75% et Anios Surfaces Hautes, sans matière abrasive
- Piètement : nettoyage à l'eau savonneuse uniquement (solvants proscrits) sans matière abrasive

GARANTIE

- Châssis : 5 ans
- Sellerie : 1 an



CONTACT

CARINA
Médical

Parc d'entreprises Visionis
278 rue de l'industrie
01090 GUÉREINS- FRANCE

SERVICE COMMERCIAL

Tél : +33(0)4 74 66 69 49
Fax : +33(0)4 74 66 69 50
commercial@carinamedical.com