



*Folding screen*

**114 range**

**114 02**

**CARINA**  
*Medical*



**CE**

ISO 9001  
ISO 13485

## TECHNICAL DETAILS

- Folding screens with 2 panels
- Panels mounted on hinges
- Fire retardant upholstery, M1 class
- Structure in square steel tubes with epoxy covering, light grey color (RAL 7035) in standard
- Equipped with 6 wheels diam. 50mm

## DIMENSIONS

- Panels width 1000x1000mm
- Unfold length 2m
- Height 1,8m

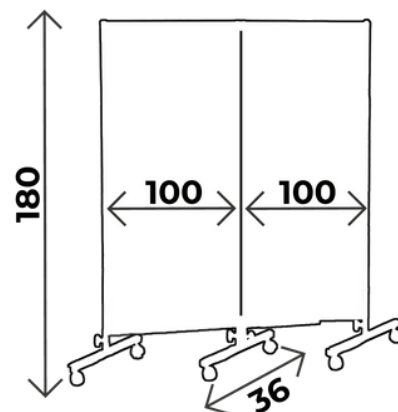

### You may also like:

Réf. 116 03: Same as 114 02 but with 3 panels



### WHAT YOU NEED TO KNOW

- ✓ Delivery time: 15 days upon receipt of order
- ✓ Warranty: 3 years (1 year for the upholstery)

# UPHOLSTERY'S COLOURS

Fire retardant  
upholstery, M1 class

*For the upholstery colours, you can choose between the Classic and Urban range  
Be careful ! Urban colours with extra value*

## *Upholstery: Classic range*

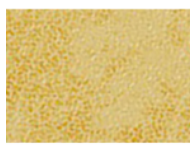

**Arno**



**Garonne**



**Potomac**



**Amour**



**Mississippi**

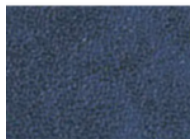

**St Laurent**

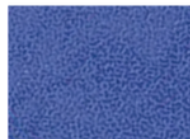

**Rhône**



**Missouri**



**Seine**

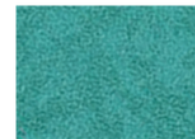

**Amazone**

## *Upholstery: Urban range*



**Aysse**

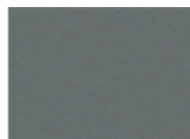

**Cendre**



**Origan**



**Géranium**



**Réglisse**



**Prune**

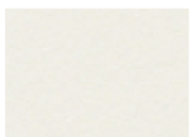

**Perle**

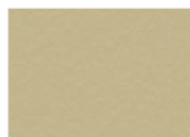

**Ficelle**

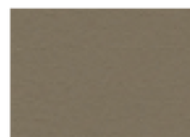

**Terre**

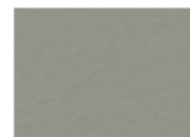

**Béton**

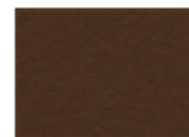

**Chataigne**

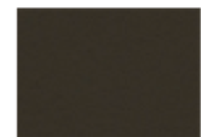

**Chocolat**

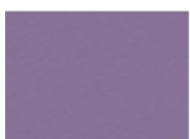

**Pensée**



**Pétrole**



**Turquoise**



**Granny**



**Absinthe**



**Ananas**



**Orange**



**Fuschia**



**Tomate**



**BASE  
COLOURS**



**RAL 9003**



**RAL 1013**



**RAL 1015**

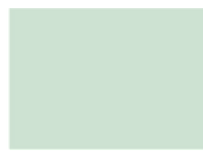

**RAL 6019**



**RAL 6033**



**RAL 6000**



**RAL 5017**



**RAL 5002**



**RAL 5000**

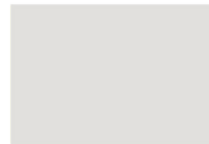

**RAL 7035**



**RAL 7016**



**RAL 9005**



**RAL 1018**



**RAL 3020**



**RAL 3003**

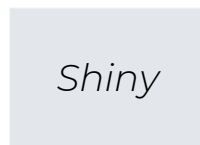

**SILVER**



# MAINTENANCE GUIDE

## **DAILY MAINTENANCE**

Upholstery: Cleaning with soapy water only (no solvents), can be disinfected with products such as Phagosept Spray, Salvanios pH10 at 0.75% and Anios Surfaces Hautes, without abrasive material

Base: cleaning with soapy water only (no solvents) without abrasive materials

## **WARRANTY**

3 years

Upholstery: 1 year



CONTACT

CARINA  
*Médical*

Parc d'entreprises Visionis  
278 rue de l'industrie  
01090 GUÉREINS- FRANCE

**COMMERCIAL SERVICE**

Tel: +33(0)4 74 66 69 49  
Fax: +33(0)4 74 66 69 50  
[export@carinamedical.com](mailto:export@carinamedical.com)