



Electric sampling chair

940 range

94001T

CARINA
Medical



CE
ISO 9001
ISO 13485

TECHNICAL DETAILS

- 3 sections electric sampling chair
- Control : Pedal
- Backrest and legrest adjustment via independent gas jacks
- The legrest maybe positioned vertically
- Trendelenburg position
- Flat upholstery with good density 35kg/cm², M1 fire retardant class, thickness 8cm
- Equipped with 2 blood test splints, adjustable in every positions with serrated blocks system
- Epoxy covering, light grey colour (RAL 7035) in standard

DIMENSIONS

- Width 55cm
- Adjustable height from 55cm to 90cm
- Load capacity : 130kg in dynamic

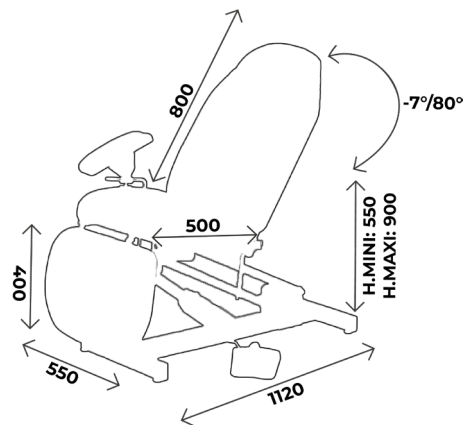

OTHER ELEMENTS

All our chairs can be put in **lying position**



WHAT YOU NEED TO KNOW

- ✓ Delivery time: 15 days upon receipt of order
- ✓ Warranty : 2 years (1 year for the upholstery)

ACCESSORIES



ACC 537

Pair of clamps diam. 14mm for blood test splints and stirrups for all ranges except LUVIA



ACC 535

Pair of double clamps diam. 14 and diam. 16mm to fix both armrest and infusion stand

ACC 516

Option synchronized backrest and legrest



ACC 105

Pair of stainless steel stirrups diam. 14mm without clamp



ACC 964

Pair of legrests on knee system in black polyurethane, diam. 14 mm, without clamp



SLFEMIREPOSE

Cover for legrests ACC964 in upholstery, the unit



ACC 514-GOUT

Plastic protection for blood test splint, the unit



ACC 514-ASSISE

Plastic protection for seatrest



ACC 514-JAMBIÈRE

Plastic protection for legrest



ACC 517-512

Plastic protection for backrest

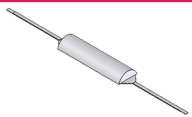

ACC 54005

Half moon head rest width 60cm fire retardant M1 class



ACC 910-PLAT02

Stainless steel tray 340x340 with clamp

ACC 910-PLAT04

Plastic tray 350x270 with clamp



ACC 113U

Pair of handles without clamp with U shape



ACC 113U-105

Pair of handles with clamps to fix both handles and stirrups



ACC 125

Paper roll holder for all models



ACC 32012

Stainless steel infusion stand diam. 16mm, 2 plastic hooks, without clamp



ACC 32014

Stainless steel infusion stand diam. 16mm, 2 stainless steel hooks without clamp



ACC 9505

Set of 4 wheels with brake diam. 50mm



ACC 993-FIXE

4 retractable wheels diam. 50mm



ACC TETERGO

Ergonomic headrest



ACC 110

Blood test splint in colour without clamp, the unit

UPHOLSTERY'S COLOURS

Fire retardant
upholstery, M1 class

For the upholstery colours, you can choose between the Classic and Urban range
Be careful ! Urban colours **with extra value**

Upholstery : Classic range



Upholstery : Urban range





BASE COLOURS

The entire 940 range is offered in light grey (RAL 7035) as standard
Possibility to change the color without extra charge

Base colour

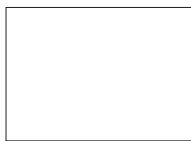

RAL 9003

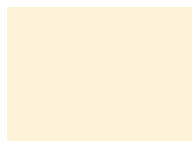

RAL 1013

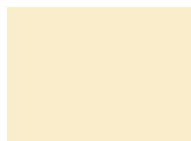

RAL 1015

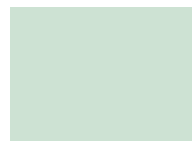

RAL 6019



RAL 6033



RAL 6000



RAL 5017



RAL 5002



RAL 5000

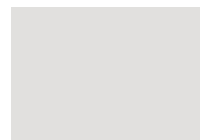

RAL 7035



RAL 7016

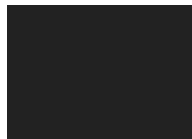

RAL 9005



RAL 1018



RAL 3020



RAL 3003

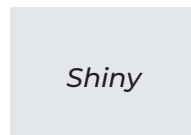

Shiny

SILVER



MAINTENANCE GUIDE

DAILY MAINTENANCE

Upholstery : Cleaning with soapy water only (no solvents), can be disinfected with products such as Phagosept Spray, Salvanios pH10 at 0.75% and Anios Surfaces Hautes, without abrasive material

Base : cleaning with soapy water only (no solvents) without abrasive materials

WARRANTY

Mechanical/ electrical part : 2 years

Upholstery : 1 year



CONTACT

CARINA
Médical

Parc d'entreprises Visionis
278 rue de l'industrie
01090 GUÉREINS- FRANCE

COMMERCIAL DEPARTMENT

Tél : +33(0)4 74 66 69 49
Fax : +33(0)4 74 66 69 50
export@carinamedical.com