



*Electric gynaecological chair*

**625 range**

**625 03T**

**CARINA**  
*Medical*



**CE**  
ISO 9001  
ISO 13485

## TECHNICAL DETAILS

- 2 sections gynaecological chair, width 60cm
- Control : Pedal
- Backrest adjustment with gas jack
- Trendelenburg position
- Flat upholstery with good density 30kg/cm<sup>2</sup>, M1 fire retardant class, thickness 8cm
- Equipped with a stainless steel drawer, a pair of clamps and a pair of stirrups
- With paper roll holder for exam sheet, on the head side
- Epoxy covering, light grey colour (RAL 7035) in standard

## DIMENSIONS

- Width 60cm
- Adjustable height from 62 to 92cm
- Load capacity : 150kg

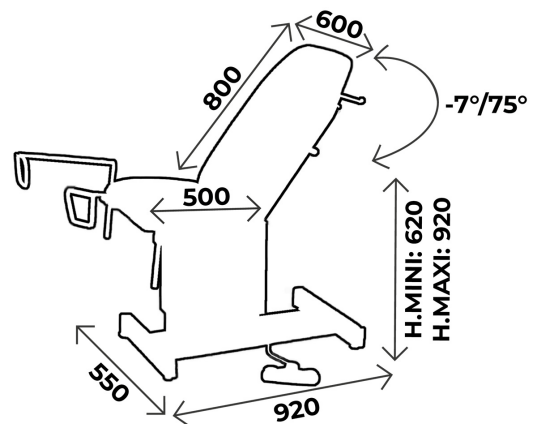

### You may also like :

Ref. **625 04T** : Same as 625 03T but 3 sections, with legrest



## WHAT YOU NEED TO KNOW

- ✓ Delivery time: 15 days upon receipt of order
- ✓ Warranty : 5 years (1 year for the upholstery)

## ACCESSORIES



**ACC 964**  
Pair of legrests on knee system in black polyurethane, diam. 14 mm, without clamp



**ACC TETERGO**  
Ergonomic head rest

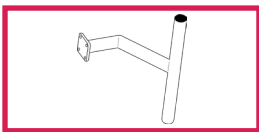

**ACC 63**  
Coloscope holder



**ACC 537**  
Pair of clamps diam. 14mm for blood test splints and stirrups for 625 and 725 range

**ACC 62524**  
Electric backrest for 625 electric height adjustment range



**ACC 997**  
4 retractable wheels diam. 50mm for 625 electric height adjustment range



**SLFEMIREPOSE**  
Cover for legrests (ACC964) in upholstery, the unit

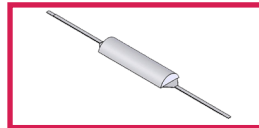

**ACC 54004**  
Half moon head rest width 60cm fire retardant M1 class for 625 range

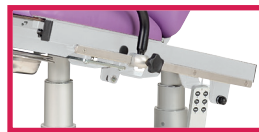

**ACC RAIL IN-L400**  
Pair of stainless steel rails dim. 25x10 length 40cm for seatrest of range 625, 725 and 524



**ACC 110**  
Blood test splint in colour without clamp, the unit

**ACC 62525**  
Electric legrest for 625 electric height adjustment range

# UPHOLSTERY'S COLOURS

Fire retardant upholstery, M1 class

For the upholstery colours, you can choose between the Classic and Urban range  
Be careful ! Urban colours **with extra value**

## *Upholstery : Classic range*



## *Upholstery : Urban range*





## BASE COLOURS

The entire 625 range is offered in light grey (RAL 7035) as standard  
Possibility to change the color without extra charge

### *Base colour*

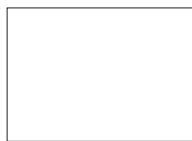

**RAL 9003**

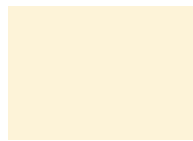

**RAL 1013**



**RAL 1015**

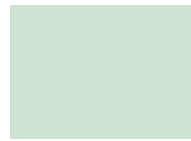

**RAL 6019**



**RAL 6033**



**RAL 6000**



**RAL 5017**



**RAL 5002**



**RAL 5000**

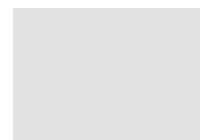

**RAL 7035**



**RAL 7016**

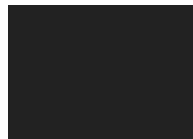

**RAL 9005**



**RAL 1018**



**RAL 3020**



**RAL 3003**

*Shiny*

**SILVER**



# MAINTENANCE GUIDE

## **DAILY MAINTENANCE**

Upholstery : Cleaning with soapy water only (no solvents), can be disinfected with products such as Phagosept Spray, Salvanios pH10 at 0.75% and Anios Surfaces Hautes, without abrasive material

Base : cleaning with soapy water only (no solvents) without abrasive materials

## **WARRANTY**

Mechanical/ electrical part : 5 years

Upholstery : 1 year



**CONTACT**

**CARINA**  
*Médical*

Parc d'entreprises Visionis  
278 rue de l'industrie  
01090 GUÉREINS- FRANCE

**COMMERCIAL DEPARTMENT**

Tél: +33(0)4 74 66 69 49  
Fax: +33(0)4 74 66 69 50  
[export@carinamedical.com](mailto:export@carinamedical.com)